

ILLUSTRATED PARTS LIST

MODEL NUMBER M6553CMD

PRODUCT NUMBER 961 41 01-24

MFG. ID. NUMBER 96141012402

ROTARY LAWN MOWER - - MODEL NUMBER M6553CMD (96141012402) PRODUCT NUMBER 961 41 01-24

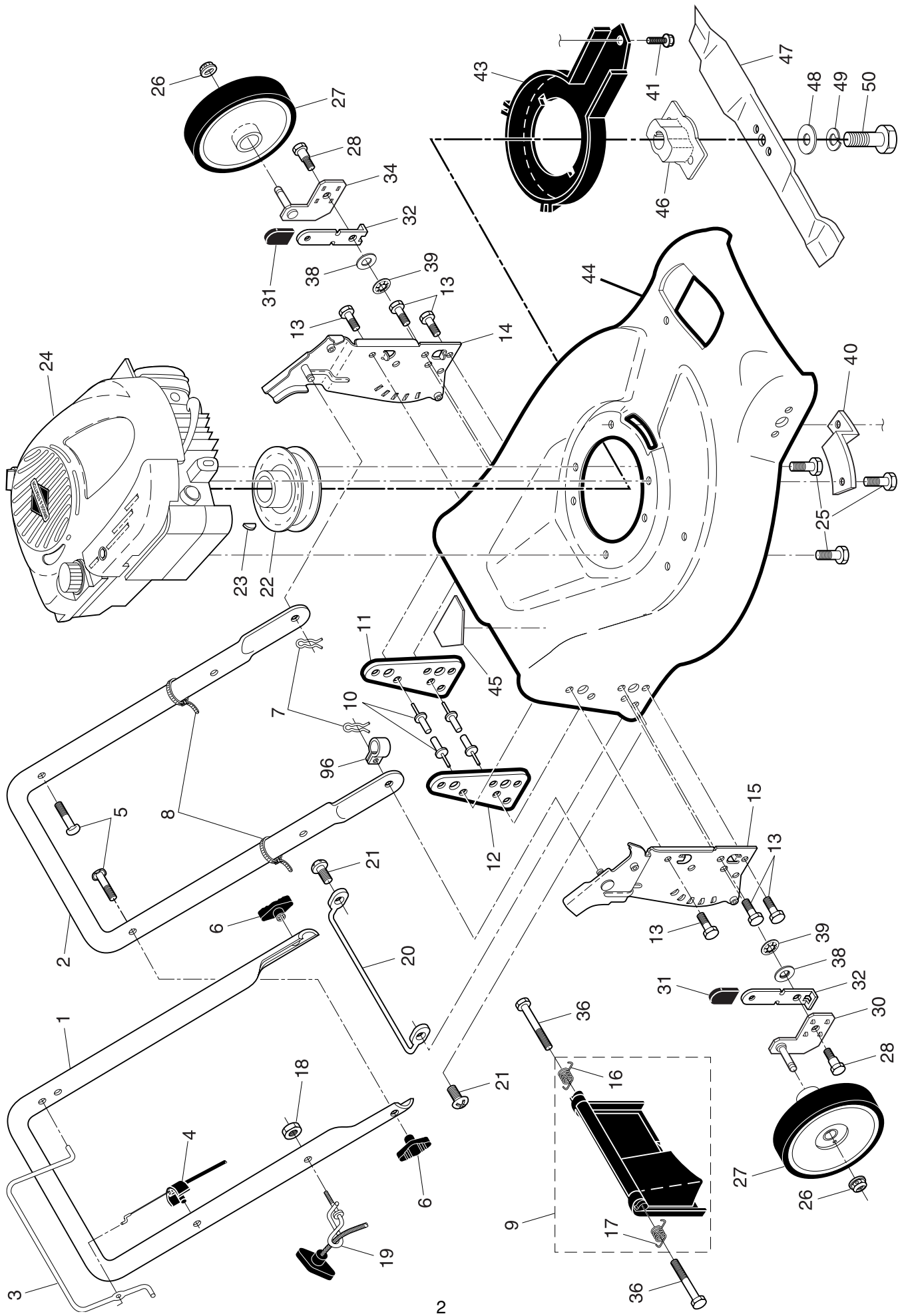

ROTARY LAWN MOWER - - MODEL NUMBER M6553CMD (96141012402) PRODUCT NUMBER 961 41 01-24

KEY NO.	PART NO.	DESCRIPTION	KEY NO.	PART NO.	DESCRIPTION
1	532 19 25-17	Upper Handle	26	532 08 39-23	Hex Flange Nut
2	532 15 36-05	Lower Handle	27	532 40 61-55	Wheel & Tire Assembly
3	532 14 67-71	Control Bar	28	532 18 93-12	Shoulder Bolt 5/16-18 x .33
4	532 18 35-67	Engine Zone Control Cable	30	532 19 54-35	Axle Arm Assembly, Rear, RH
5	532 19 15-74	Handle Bolt	31	532 08 78-77	Selector Knob
6	532 19 19-38	Handle Knob	32	532 19 01-57	Selector Spring
7	532 05 17-93	Hairpin Cotter	34	532 19 54-36	Axle Arm Assembly, Rear, LH
8	532 06 64-26	Wire Tie	36	532 18 41-93	Bolt, Hex Head
9	532 18 04-79	Rear Door Kit (Includes Key Numbers 16 and 17)	38	532 17 61-85	Washer
10	532 12 84-15	Pop Rivet	39	532 17 62-35	Pushnut
11	532 18 25-38	Support Bracket, LH	40	532 19 09-39	Mounting Bracket, Debris Shield
12	532 18 25-39	Support Bracket, RH	41	532 19 23-25	Screw
13	817 06 04-10	Screw 1/4-20 x 5/8	43	532 18 87-84	Debris Shield
14	532 19 01-54	Handle Bracket Assembly, LH	44	532 19 48-60	Kit, Lawn Mower Housing (Includes Key Numbers 10, 11, 12 and 45)
15	532 19 01-53	Handle Bracket Assembly, RH	45	532 18 21-66	Danger Decal
16	532 18 00-71	Spring, Rear Door, LH	46	532 18 46-32	Blade Adapter
17	532 18 00-72	Spring, Rear Door, RH	47	532 19 93-77	Blade, 21"
18	532 13 20-04	Keps Locknut 1/4-20	48	532 85 10-74	Hardened Washer
19	532 19 47-88	Rope Guide	49	532 85 02-63	Helical Washer 3/8-24 x 1-3/8 Grade 8
20	532 17 92-05	Foot Guard, C.E.	50	532 85 10-84	Hex Head Machine Screw 3/8-24 x 1-3/8 Grade 8
21	532 05 45-83	Screw, Tapping 1/4-20 x 1/2	96	532 19 79-91	Clip, Cable
22	532 18 49-41	Engine Pulley	--	532 18 21-34	Decal, Warning (not shown)
23	532 08 76-77	Hi-Pro Key	--	532 40 35-50	Operator's Manual, European
24	---	Engine, Briggs & Stratton, Model Number 124K02 (order parts from engine manufacturer)	--	532 40 35-51	Operator's Manual, Scandinavian
25	532 15 04-06	Hex Head Thread Rolling Screw 3/8-16 x 1-1/8	--	532 40 35-52	Operator's Manual, East Bloc
			--	532 40 35-53	Operator's Manual, Baltic

NOTE: All component dimensions given in U.S. inches. 1 inch = 25.4 mm. **IMPORTANT:** Use only Original Equipment Manufacturer (O.E.M.) replacement parts. Failure to do so could be hazardous, damage your lawn mower and void your warranty.

ROTARY LAWN MOWER - - MODEL NUMBER M6553CMD (96141012402) PRODUCT NUMBER 961 41 01-24

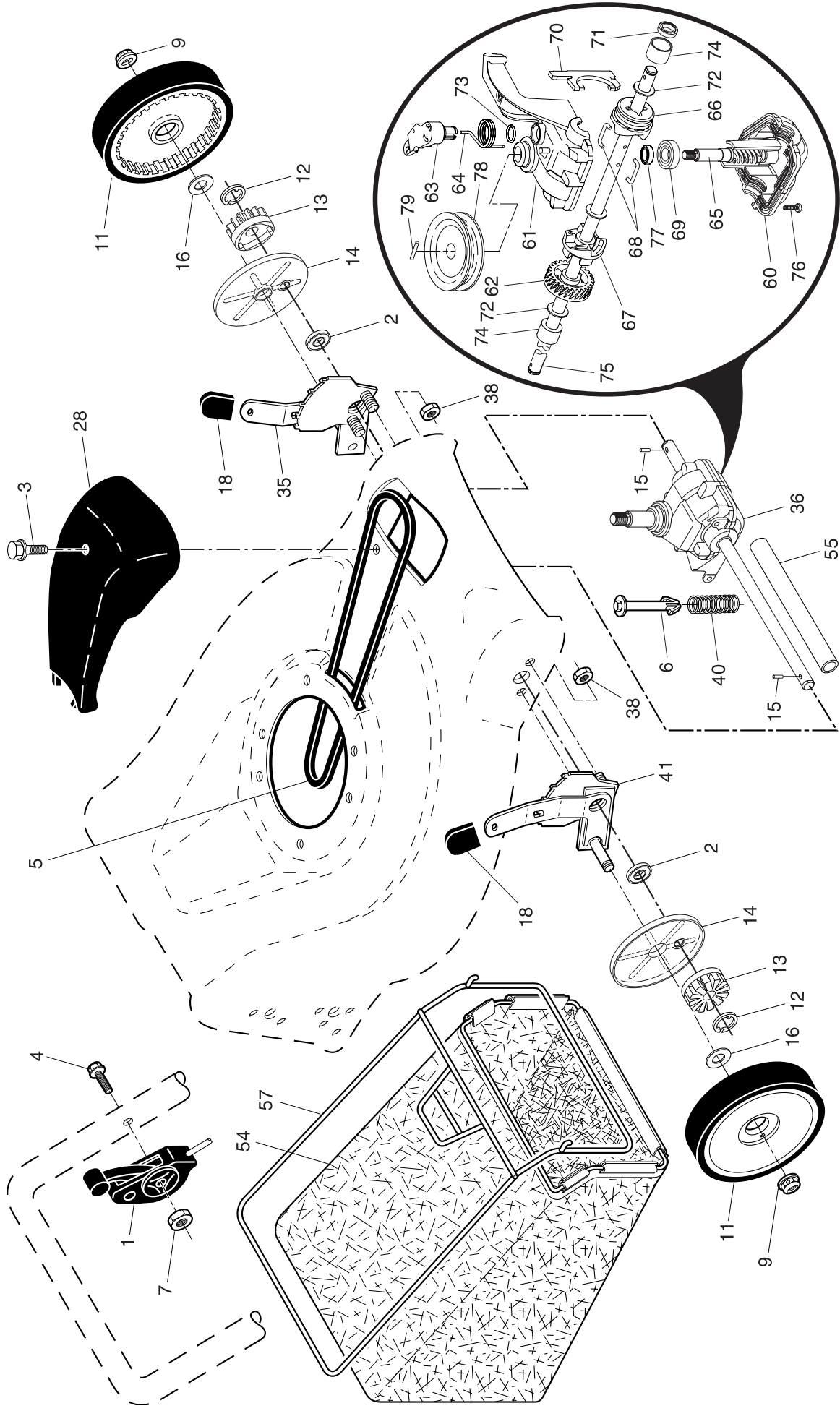

ROTARY LAWN MOWER - - MODEL NUMBER M6553CMD (96141012402) PRODUCT NUMBER 961 41 01-24

KEY PART NO.	PART NO.	DESCRIPTION	KEY PART NO.	PART NO.	DESCRIPTION
1	532 18 45-88	Control Cable Assembly	55	532 17 57-39	Driveshaft Cover
2	532 19 10-39	Bearing, Wheel Adjuster	57	532 19 46-43	Frame, Grassbag
3	532 17 52-62	Pan Head Tapping Screw #10-24 x 2-3/4	60	532 18 34-97 *	Case, Lower
4	532 15 87-55	Hex Washer Head Screw 1/4-20 x 2.12	61	532 18 34-98 *	Case, Upper
5	532 17 54-36	V-Belt	62	532 18 34-99	Gear, 27 Teeth
6	532 15 04-95	Spring Retainer	63	532 18 35-00	Lever, Clutch
7	532 19 17-30	Locknut, Hex #10-24	64	532 18 35-01	Spring, Return
9	532 08 39-23	Locknut, Hex	65	532 18 35-02	Shaft, Input
11	532 40 29-36	Wheel & Tire Assembly	66	532 18 35-03	Dog, Movable
12	812 00 00-58	E-Ring	67	532 18 35-04	Dog, Fixed
13	532 75 00-03	Pinion	68	532 18 35-05	Wire, Formed
14	532 18 94-03	Dust Cover	69	532 18 35-06	Bearing, Ball
15	532 19 10-17	Pawl, Drive	70	532 18 35-07	Fork, Shift
16	532 06 77-25	Washer 1/2 x 1-1/2 x .134	71	532 18 35-08	Seal, Output Shaft
18	532 08 78-77	Selector Knob	72	532 18 35-09	Washer
28	532 18 14-68	Drive Cover	73	532 18 35-10	Seal, Case
35	532 19 51-10	Kit, Wheel Adjuster, LH (Includes Knob and Bearing)	74	532 18 35-11	Bushing
36	532 19 92-05	Gearcase Assembly, Complete	75	532 19 66-13	Shaft, Output
38	873 80 04-00	Locknut, Hex 1/4-20	76	532 18 35-13	Screw
40	532 13 70-90	Spring	77	532 18 35-14	Seal, Input Shaft
41	532 19 51-07	Kit, Wheel Adjuster, RH (Includes Knob and Bearing)	78	532 19 98-52	Drive Pulley
54	532 40 19-05	Grassbag Assembly	79	532 19 94-19	Pin, Retaining

* Use Dow Corning #709 to reseal Gear Case Halves.

NOTE: All component dimensions given in U.S. inches. 1 inch = 25.4 mm. **IMPORTANT:** Use only Original Equipment Manufacturer (O.E.M.) replacement parts. Failure to do so could be hazardous, damage your lawn mower and void your warranty.