

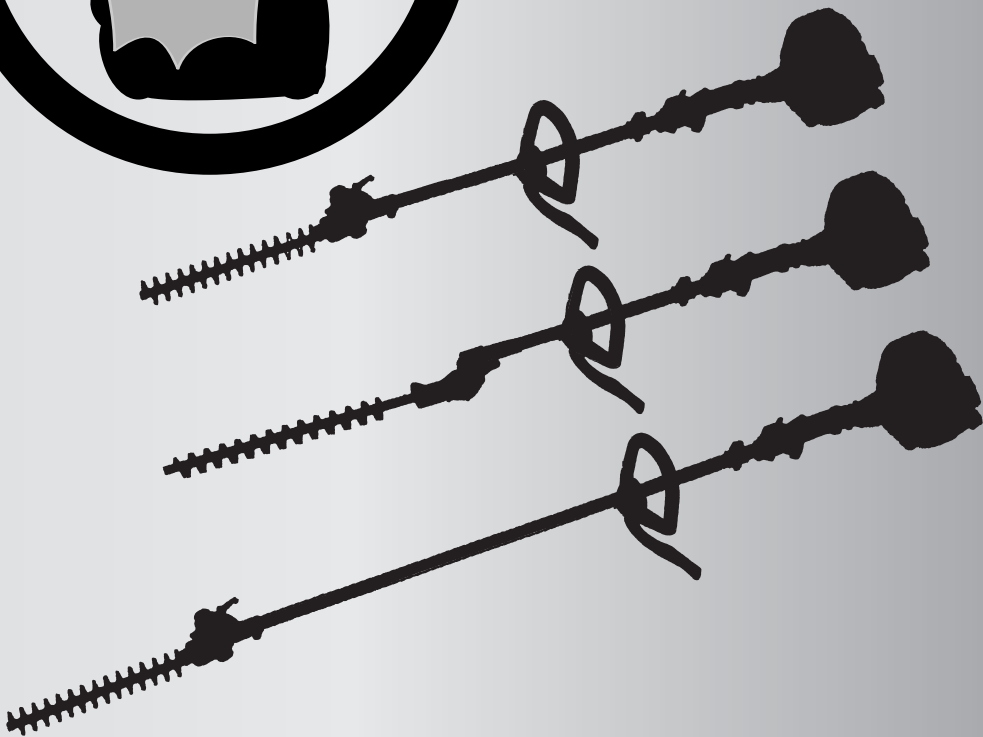

OWNER'S MANUAL

**SHORT REACH TRIMMER
LONG REACH TRIMMER**



SRTZ2610 SRTZ2610F LRTZ2610

Original Language

WARNING

 Before using our products, please read this manual carefully to understand the proper use of your unit.

EC DECLARATION OF CONFORMITY

(Applies to Europe only)

The undersigned manufacturer,
Husqvarna Zenoah Co.,Ltd.,
1-9, Minamidai, Kawagoe, Saitama, Japan,

declares under sole responsibility that the following products referred to in this declaration conform with the requirement of the following COUNCIL'S DIRECTIVE.

The products referred to are :

DESIGNATION : **SHORT REACH TRIMMERS/LONG REACH TRIMMERS**
MANUFACTURER : **Husqvarna Zenoah Co., Ltd.**
MODELS : **SRTZ2610/SRTZ2610F/LRTZ2610**
SERIAL NUMBERS DATING : **2010 and onwards**
(The year is clearly stated on the rating plate,
followed by the serial number)

This declaration conform with :

- **DIRECTIVE 2006/42/EC**
(The following standards have been applied: ISO 12100-1,-2, FprEN 15503: 2009)
- **DIRECTIVE 2004/108/EC**
(The following standards have been applied: EN 61000-6-1, EN 55012 (CISPR 12: 2005))
- **DIRECTIVE 2000/14/EC**
conformity assessment procedure followed ANNEX V
(The following standards have been applied: ISO 11094)
- **DIRECTIVE 2002/88/EC**
- **ENISO 10517**

Date : 29 December 2009

Signature : 

Kiyoshi Honda
General Manager, Development Center

Authorised representative :
Husqvarna AB
SE-561 82 Huskvarna, Sweden
Person authorised to compile the technical file :
Bo R Jonsson
SE-561 82 Huskvarna, Sweden

EXPLANATION OF SYMBOLS AND SAFETY WARNINGS

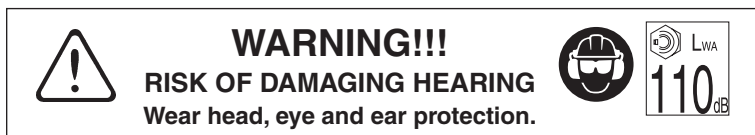

MODEL		SOUND LEVEL ¹⁾		VIBRATION LEVEL ²⁾
		ISO 11094 ISO 10517		ISO 22867
		LpAeq	LwA	ahv, eq
			guaranteed	
SRTZ2610	25.4 cm ³	95 dB(A)	110 dB(A)	6.6 m/s ²
SRTZ2610F	25.4 cm ³	93 dB(A)	110 dB(A)	11.1 m/s ²
LRTZ2610	25.4 cm ³	99 dB(A)	110 dB(A)	5.5 m/s ²

* Specifications are subject to change without notice

1) Noise emissions in the environment measured as sound power (L_{WA}) in conformity with EC directive 2000/14/EC.

Reported soundpower level for the machine has been measured with the original cutting attachment that gives the highest level.

The difference between guaranteed and measured sound power is that the guaranteed sound power also includes dispersion in the measurement result and the variations between different machines of the same model according to Directive 2000/14/EC.

Reported data for equivalent sound pressure level (L_{pAeq}) at the operator's ear for the machine has a typical statistical dispersion (standard deviation) of 1 dB (A).

2) Reported data for equivalent vibration level ($a_{hv,eq}$) at the control handle has a typical statistical dispersion (standard deviation) of 1 m/s².

APPROVAL NUMBER OF CE EXHAUST EMISSION REGULATION
DIRECTIVE 97/68/EC AMENDED 2002/88/EC
e13*97/68SH2G3*2002/88*0404*00

▲ SAFETY FIRST

Instructions contained in warnings within this manual marked with a ▲ symbol concern critical points which must be taken into consideration to prevent possible serious bodily injury, and for this reason you are requested to read all such instructions carefully and follow them without fail.

WARNINGS IN THE MANUAL**▲ WARNING**

This mark indicates instructions, which must be followed in order to prevent accidents, which could lead to serious bodily injury or death.

❗ IMPORTANT

This mark indicates instructions, which must be followed, or it leads to mechanical failure, breakdown, or damage.

📖 NOTE

This mark indicates hints or directions useful in the use of the product.

Information

This machine is equipped with an Overload Cancellation Mechanism.

When the cutting blades have got into metal wires or twigs difficult to cut, the mechanism works as a shock absorber, and protects the gears and the blades from severe reaction which could give damage to those parts.

When the blades are frequently caught by twigs, please check the following points:

1. Size of the twigs -->▲ Never try to cut twigs thicker than 5 mm.
2. Condition of the blade edges -->▲ Replace the worn-out blades.

Thank you for choosing our product.

Contents

1. Parts location	3
2. Specifications	4
3. Warning labels on the machine	4
4. Symbols on the machine	4
5. For safe operation	5
6. Set up	8
7. Fuel	9
8. Operation	10
9. Maintenance	12
10. Storage	14
11. Disposal	14
12. Troubleshooting guide	15

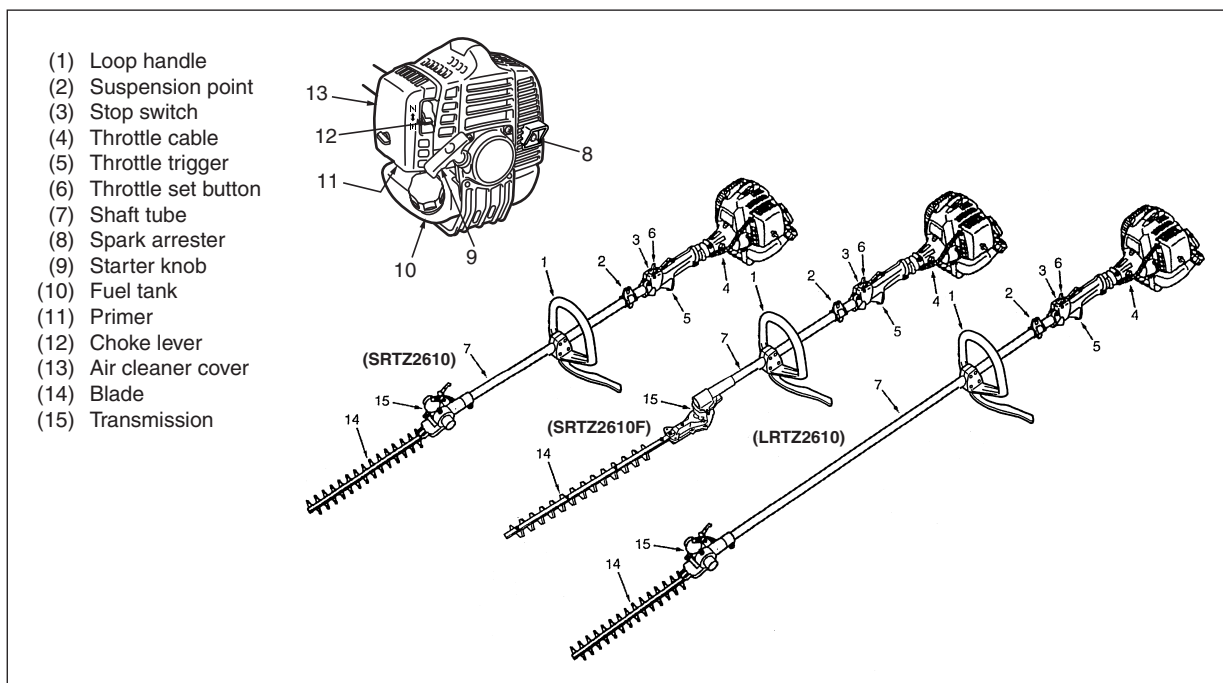
1. Parts location

2. Specification

Model		SRTZ2610	SRTZ2610F	LRTZ2610
Overall size (LxWxH)	mm	1725 x 400 x 365	1734 x 338 x 254	2300 x 400 x 365
Dry weight *	kg	6.4	6.5	6.6
Engine	Type	Air-cooled 2-stroke gasoline		
	Model	Zenoah GZ25N		
	Max output	rpm	1.2Hp (0.9kW) at 7500min ⁻¹	
	Idle speed	rpm	3000±200min ⁻¹	
	Displacement	cm ³	25.4	
	Fuel	Mixture (Gasoline 50 : Oil 1) (when using ZENOAH genuine oil)		
	Carburetor	Walbro Diaphragm type		
	Spark plug	NGK CMR7H		
Fuel tank capacity	L	0.65		
Transmission	Centrifugal clutch, Spiral bevel gear, Cam crank			
Reduction ratio		4.0	4.25	4.0

Specifications are subject to change without notice.

* Harness and protective cover are not included.

3. Warning labels on the machine



If warning label peels off or becomes soiled and impossible to read, you should contact the dealer from which you purchased the product to order new labels and affix them in the required location(s).



Never modify your machine.
We won't warrant the machine, if you use the remodeled trimmer or if you don't observe the proper usage written in the manual.

4. Symbols on the machine

For safe operation and maintenance, symbols are carved in relief on the machine. According to these indications, please be careful not to make a mistake. The port to refuel the "MIX GASOLINE"



Position: FUEL TANK CAP



The direction to close the choke
Position: ENGINE COVER



The direction to open the choke
Position: ENGINE COVER

▲ 5. For safe operation



1. Read this manual carefully until you completely understand and follow all safety and operating instructions.
2. Keep this manual handy so that you may refer to it later whenever any questions arise. Also note, if you have any questions which cannot be answered herein, contact the dealer from whom you purchased the product.
3. Always be sure to include this manual when selling, lending, or otherwise transferring the ownership of this product.
4. Never allow children or anyone unable to fully understand the directions given in the manual to use the machine.



WORKING CONDITION

1. When using the product, you should wear proper clothing and protective equipment.

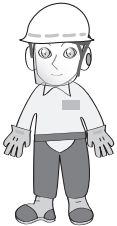

- (1) Helmet
- (2) Ear protectors
- (3) Protection goggles or face protector
- (4) Thick work gloves
- (5) Non-slip-sole work boots

2. And you should carry with you.
 - (1) Attached tools
 - (2) Properly reserved fuel
 - (3) Spare blade
 - (4) Things to notify your working area (rope, warning signs)
 - (5) Whistle (for collaboration or emergency)
 - (6) Hatchet or saw (for removal of obstacles)



3. Do not wear loose clothing, jewelry, short trousers, sandals, or go barefoot. Do not wear anything which might be caught by a moving part of the unit. Secure hair so it is above shoulder length.

WORKING CIRCUMSTANCE

1. Never start the engine inside a closed room or building. Exhaust gases contain dangerous carbon monoxide.
2. Never use the product,
 - a. when the ground is slippery or when you can't maintain a steady posture.



- b. At night, at times of heavy fog, or at any other times when your field of vision might be limited and it would be difficult to gain a clear view of the working area.
- c. During rain storms, during lightning storms, at times of strong or gale-force winds, or at any other times when weather conditions might make it unsafe to use the product.

WORKING PLAN

1. You should never use the product when under the influence of alcohol, when suffering from exhaustion or lack of sleep, when suffering from drowsiness as a result of having taken cold medicine or at any other time when a possibility exists that your judgment might be impaired or that you might not be able to operate the product properly and in a safe manner.
2. When planning your work schedule, allow plenty of time to rest. Limit the amount of time over which the product is to be used continuously to somewhere around 30 ~ 40 minutes per session, and take 10 ~ 20 minutes of rest between work sessions. Also try to keep the total amount of work performed in a single day under 2 hours or less.



▲ WARNING

1. If you don't observe the working time, or working manner (See "USING THE PRODUCT"), Repetitive Stress Injury (RSI) could occur.
If you feel discomfort, redness and swelling of your fingers or any other part of your body, see a doctor before getting worse.
2. To avoid noise complaints, in general, operate product between 8 a.m. and 5 p.m. on weekdays and 9 a.m. to 5 p.m. on weekends.



NOTE

Check and follow the local regulations as to sound level and hours of operations for the product.

▲ 5. For safe operation

BEFORE STARTING THE ENGINE



1. The area within a perimeter of 15 m (50 ft) of the person using the product should be considered a hazardous area into which no one should enter. If necessary, yellow warning rope, warning signs should be placed around the perimeter of the area. When work is to be performed simultaneously by two or more persons, care should also be taken to constantly look around or otherwise check for the presence and locations of other people working so as to maintain a distance between each person sufficient to ensure safety.
2. Check the condition of working area to avoid any accident by hitting hidden obstacles such as stumps, stones, cans, or broken glass.

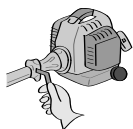

❗ IMPORTANT

Remove any obstacle before beginning work.

3. Inspect the entire unit for loose fasteners and fuel leakage. Make sure that the cutting attachment is properly installed and securely fastened.
4. Always use the harness. Adjust the harness for comfort before starting the engine. The harness should be adjusted so the left hand can comfortably hold the handlebar grip approximately waist high.

STARTING THE ENGINE

1. Keep bystanders and animals at least 15 m (50 ft) away from the operating point. If you are approached, immediately stop the engine.
2. The product is equipped with a centrifugal clutch mechanism, so the cutting attachment begins to rotate as soon as the engine is started by putting the throttle trigger into the start position. When starting the engine, place the product onto the ground in a flat clear area and hold it firmly in place so as to ensure that neither the cutting attachment nor the

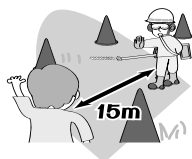

throttle trigger come into contact with any obstacle when the engine starts.

▲ WARNING

Never place the throttle trigger into the high-speed position when starting the engine.

3. After starting the engine, check to make sure that the cutting attachment stops rotating when the throttle is moved fully back to its original position. If it continues to rotate even after the throttle trigger has been moved fully back, turn off the engine and take the unit to your authorized ZENOAH servicing dealer for repair.

USING THE PRODUCT

❗ IMPORTANT

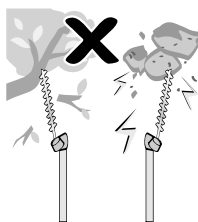

Cut only materials recommended by the manufacturer. And use only for tasks explained in the manual.

1. Grip the handles firmly with both hands using your whole hand. Place your feet slightly apart (slightly further apart than the width of your shoulders) so that your weight is distributed evenly across both legs, and always be sure to maintain a steady, even posture while working.
2. Maintain the speed of the engine at the level required to perform cutting work, and never raise the speed of the engine above the level necessary.
3. If the unit starts to shake or vibrate, turn off the engine and check the whole unit. Do not use it until the trouble has been properly corrected.
4. Keep all parts of your body away from moving cutting attachment and hot surfaces.
5. Never touch the muffler, spark plug, or other metallic parts of the engine while the engine is in operation or immediately after shutting down the engine. Doing so could result in serious burns or electrical shock.



▲ 5. For safe operation

• IF SOMEONE COMES

1. Guard against hazardous situations at all times. Warn adults to keep pets and children away from the area. Be careful if you are approached. Injury may result from flying debris.
2. If someone calls out or otherwise interrupts you while working, always be sure to turn off the engine before turning around.

MAINTENANCE

1. In order to maintain your product in proper working order, perform the maintenance and checking operations described in the manual at regular intervals.
2. Always be sure to turn off the engine before performing any maintenance or checking procedures.



▲ WARNING

The metallic parts reach high temperatures immediately after stopping the engine.

3. When replacing the cutting attachment or any other part, or when replacing the oil or any lubricant, always be sure to **use only ZENOAH products or products which have been certified by ZENOAH for use with the ZENOAH product.**
4. In the event that any part must be replaced or any maintenance or repair work not described in this manual must be performed, please contact a representative from the store nearest ZENOAH authorized servicing dealer for assistance.
5. Do not use any accessory or attachment other than those bearing the ZENOAH mark and recommended for the unit.
6. Under no circumstances should you ever take apart the product or alter it in any way. Doing so might result in the product becoming damaged during operation or the product becoming unable to operate properly.

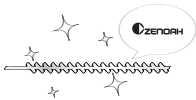

HANDLING FUEL

1. The engine of the ZENOAH product is designed to run on a mixed fuel, which contains highly flammable gasoline. Never store cans of fuel or refill the tank of the unit in any place where there is a boiler, stove, wood fire, electrical sparks, welding sparks, or any other source of heat or fire which might ignite the fuel.
2. Never smoke while operating the unit or refilling its fuel tank.
3. When refilling the tank, always turn off the engine and allow it to cool down. Take a careful look around to make sure that there are no sparks or open flames anywhere nearby before refueling.
4. Wipe spilled fuel completely using a dry rag if any fuel spillage occurs during refueling.
5. After refueling, screw the fuel cap back tightly onto the fuel tank and then carry the unit to a spot 3 m or more away from where it was refueled before turning on the engine.

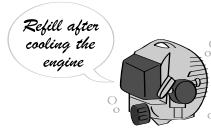

TRANSPORTATION

1. When hand-carrying the product, cover over the cutting attachment if necessary, lift up the product and carry it paying attention to the cutting attachment.
2. Never transport the product over rough roads over long distances by vehicle without removing all fuel from the fuel tank. If doing so, fuel might leak from the tank during transport.

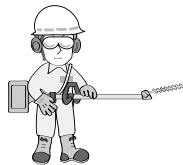

6. Set up

A Package contains the items as illustrated.

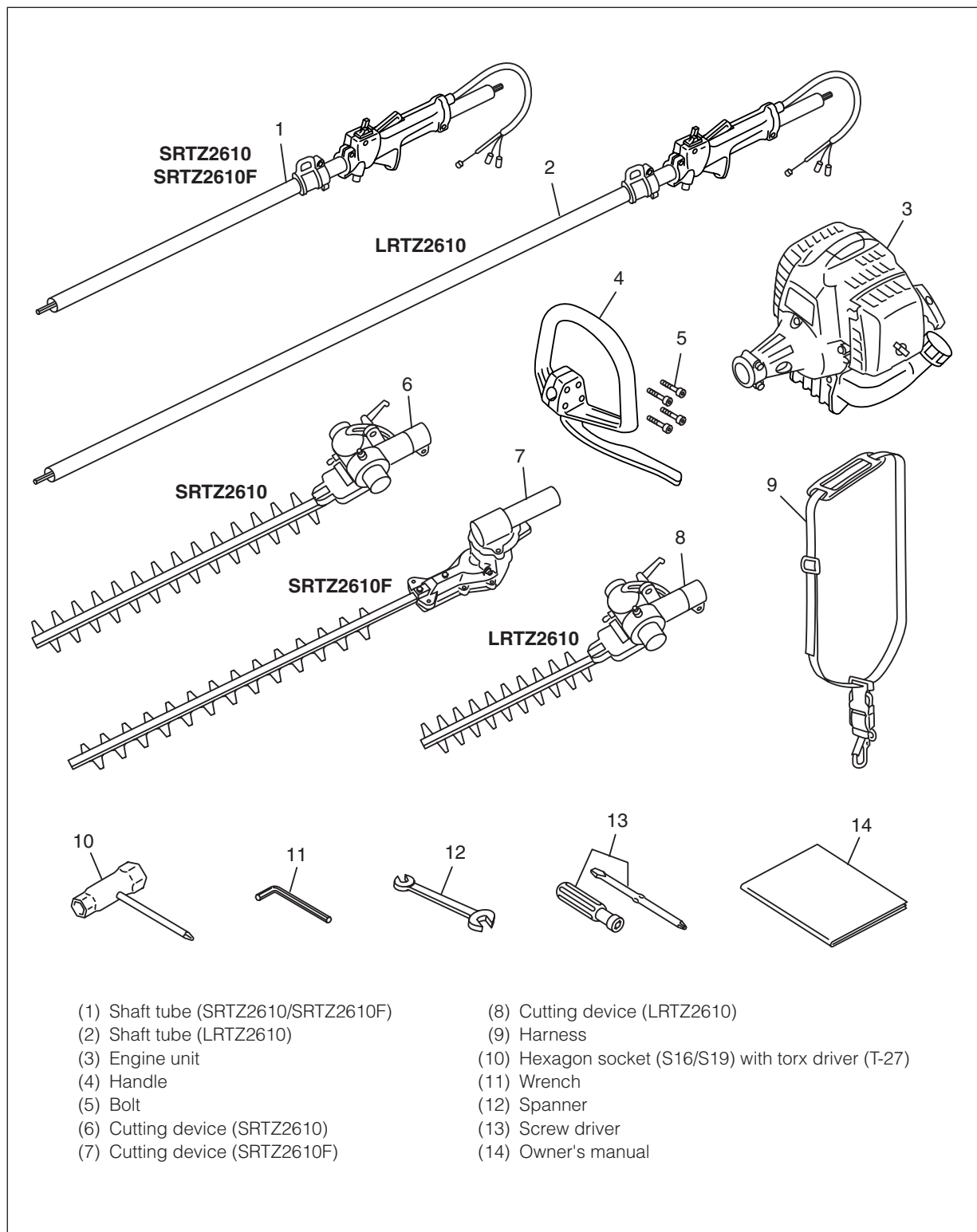

- | | |
|-------------------------------------|---|
| (1) Shaft tube (SRTZ2610/SRTZ2610F) | (8) Cutting device (LRTZ2610) |
| (2) Shaft tube (LRTZ2610) | (9) Harness |
| (3) Engine unit | (10) Hexagon socket (S16/S19) with torx driver (T-27) |
| (4) Handle | (11) Wrench |
| (5) Bolt | (12) Spanner |
| (6) Cutting device (SRTZ2610) | (13) Screw driver |
| (7) Cutting device (SRTZ2610F) | (14) Owner's manual |

6. Set up

MOUNTING ENGINE

1. Push the shaft tube toward the clutch housing and move it by hand to check that the power transmission shaft is engaged with the gears.
2. Insert the shaft tube into the clutch housing until it bottoms, and align the positioning holes on the clutch housing and the shaft tube and install the screw. When difficult to engage, twist the engine slightly.
3. Fasten the clamp securely with two screws.

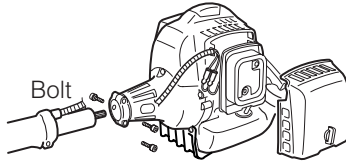

⚠ WARNING

Never use any screws other than those specified by the manufacturer, or the engine can get loose, resulting in a hazardous event.

🔧 IMPORTANT

Tighten the screws gradually by turns.

CONNECTING THROTTLE WIRE

1. Remove the air cleaner cover.
2. Connect the end of the throttle wire to the joint on the top of the carburetor.

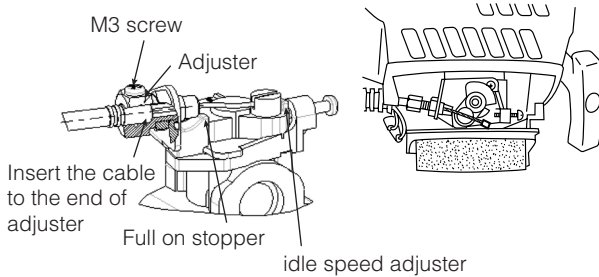

1. Connect throttle wire with carburetor. Insert the cable to the end of adjuster fix the throttle cable by tightening M3 screw. (Tightening torque: 0.4 ~ 0.8 N.m.)
2. Make sure the 'STOPPER-PLATE' of carburetor moves to contact with 'IDLE SPEED ADJUSTER' and the 'SWING-ARM' of carburetor moves to contact with 'FULL ON STOPPER' by gripping throttle trigger.

CONNECTING SWITCH WIRES

- Connect the switch wires between the engine and the main unit. Pair the wires of the same color.

SUSPENSION POINT

📖 NOTE

Be the suspension point in the location of the arrow mark.

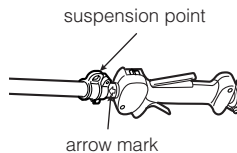

INSTALLING HANDLE

📖 NOTE

The handle is put during the arrow mark.

- Mount the handle to the shaft tube and suspension point it at a location that is comfortable to you.

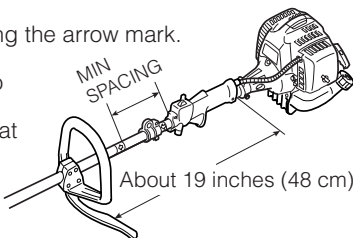

ATTACHING THE TRIMMING MECHANISM

1. Remove the screw screwed into the end of the transmission.
2. Insert the end of the tube into the transmission.
3. Line up the hole on the end of the transmission into which the screw is to be inserted with the screw hole on the tube, and screw the screw firmly in.
4. Using a wrench, screw the bolt provided to fix the transmission into place.

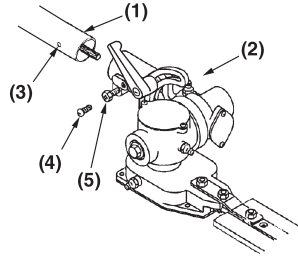

- (1) Tube
- (2) Transmission
- (3) Screw hole
- (4) Screw
- (5) Fastening bolt

HARNESS

⚠ WARNING

ALWAYS WEAR THE PROVIDED HARNESS WHEN USING THE MACHINE!

Always make sure the machine is hooked securely to the harness.

If you don't, you will be unable to control the machine safely. This can result in injury to yourself or others. Never use a harness with a defective quick release or any other damage.

HOW TO WEAR

1. Wear the provided harness without twisted bands, with the hanger on your right side.

- (1) Hanger

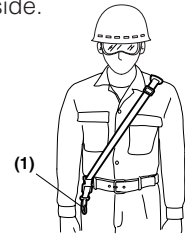

QUICK RELEASE

The harness is equipped with a "QUICK RELEASE" device. To release the machine from the harness in emergency situations, please follow the procedure as explained below.

⚠ WARNING

Make sure to check proper working of the QUICK RELEASE device BEFORE operating the machine. Make sure to hold the unit securely when using the QUICK RELEASE.

While holding the unit by your left hand securely, press both sides of the buckle.

- (1) Buckle

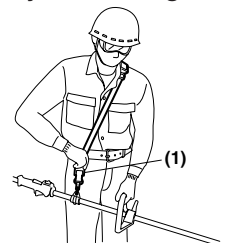

BALANCE UNIT

1. Put on harness and attach unit to harness
2. Depending on the working posture, slide clamp up or down until unit balances and the harness fits your body.

7. Fuel

■ FUEL

▲ WARNING

- **Gasoline is very flammable. Avoid smoking or bringing any flame or sparks near fuel. Make sure to stop the engine and allow it cool before refueling the unit. Select outdoor bare ground for fueling and move at least 3 m (10 ft) away from the fueling point before starting the engine.**



- The Zenoah engines are lubricated by oil specially formulated for air-cooled 2-cycle gasoline engine use. If Zenoah oil is not available, use an anti-oxidant added quality oil expressly labeled for air-cooled 2-cycle engine use (JASO FC GRADE OIL or ISO EGC GRADE).
- Do not use BIA or TCW (2-stroke water-cooling type) mixed oil.

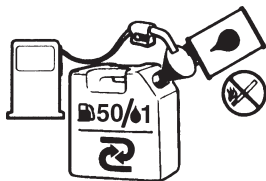

■ RECOMMENDED MIXING RATIO

GASOLINE 50 : OIL 1

(when using ZENOAH genuine oil)

- **Exhaust emission are controlled by the fundamental engine parameters and components (eq., carburation, ignition timing and port timing) without addition of any major hardware or the introduction of an inert material during combustion.**
- These engines are certified to operate on unleaded gasoline.
- Make sure to use gasoline with a minimum octane number of 89RON (USA/Canada: 87AL).
- If you use a gasoline of a lower octane value than prescribed, there is a danger that the engine temperature may rise and an engine problem such as piston seizing may consequently occur.
- Unleaded gasoline is recommended to reduce the contamination of the air for the sake of your health and the environment.
- Poor quality gasolines or oils may damage sealing rings, fuel lines or fuel tank of the engine.

■ HOW TO MIX FUEL

❗ IMPORTANT

Pay attention to agitation.

1. Measure out the quantities of gasoline and oil to be mixed.
2. Put some of the gasoline into a clean, approved fuel container.

3. Pour in all of the oil and agitate well.
4. Pour in the rest of gasoline and agitate again for at least one minute. As some oils may be difficult to agitate depending on oil ingredients, sufficient agitation is necessary for the engine to last long. Be careful that, if the agitation is insufficient, there is an increased danger of early piston seizing due to abnormally lean mixture.
5. Put a clear indication on the outside of the container to avoid mixing up with gasoline or other containers.
6. Indicate the contents on outside of container for easy identification.

■ FUELING THE UNIT

1. Untwist and remove the fuel cap. Rest the cap on a dustless place.
2. Put fuel into the fuel tank to 80% of the full capacity.
3. Fasten the fuel cap securely and wipe up any fuel spillage around the unit.

▲ WARNING

1. **Select bare ground for fueling.**
2. **Move at least 10 feet (3 meters) away from the fueling point before starting the engine.**
3. **Stop the engine before refueling the unit. At that time, be sure to sufficiently agitate the mixed gasoline in the container.**

■ FOR YOUR ENGINE LIFE, AVOID:

1. **FUEL WITH NO OIL (RAW GASOLINE)** – It will cause severe damage to the internal engine parts very quickly.
2. **GASOHOL** – It can cause deterioration of rubber and/or plastic parts and disruption of engine lubrication.
3. **OIL FOR 4-CYCLE ENGINE USE** – It can cause spark plug fouling, exhaust port blocking, or piston ring sticking.
4. **Mixed fuels which have been left unused for a period of one month or more** may clog the carburetor and result in the engine failing to operate properly.
5. In the case of storing the product for a long period of time, clean the fuel tank after rendering it empty. Next, activate the engine and empty the carburetor of the composite fuel.
6. In the case of scrapping the used mixed oil container, scrap it only at an authorized repository site.

📖 NOTE

As for details of quality assurance, read the description in the section Limited Warranty carefully. Moreover, normal wear and change in product with no functional influence are not covered by the warranty. Also, be careful that, if the usage in the instruction manual is not observed as to the mixed gasoline, etc. described therein, it may not be covered by the warranty.

8. Operation

STARTING ENGINE

⚠ WARNING

The cutting head will start moving upon the engine starts.

1. Rest the unit on a flat, firm place. Keep the cutting head off the ground and clear of surrounding objects as it will start moving upon starting of the engine.
2. Push the primer several times until overflow fuel flows out in the clear tube.

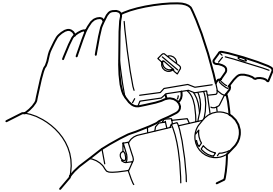

3. Move the choke lever to the closed position.

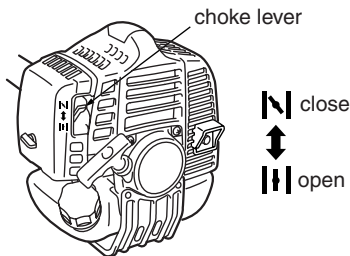

4. Set the stop switch to the "RUN" position. While pulling the throttle trigger(1,2), push the throttle set button(3), and release the throttle trigger(2), then the throttle trigger is in to the "start position".

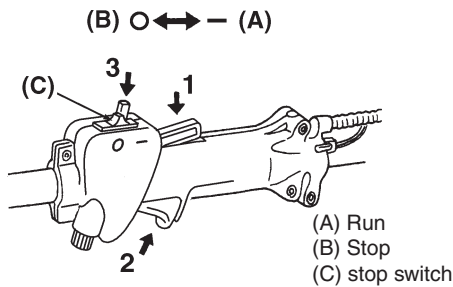

5. While holding the unit firmly, pull out the starter rope quickly until engine fires.

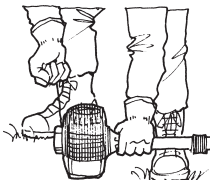

ⓘ IMPORTANT

Avoid pulling the rope to its end or returning it by releasing the knob. Such actions can cause starter failures.

6. Move the choke lever downward to open the choke. And restart the engine.
7. Allow the engine to warm up for a several minutes before starting operation.

📖 NOTE

1. When restarting the engine immediately after stopping it, leave the choke open.
2. Overchoking can make the engine hard to start due to excess fuel. When the engine failed to start after several attempts, open the choke and repeat pulling the rope, or remove the spark plug and dry it.

STOPPING ENGINE

1. Release the throttle trigger and run the engine for a half minute.
2. Shift the stop switch to the "Stop" position.

ⓘ IMPORTANT

Except for an emergency, avoid stopping the engine while pulling the throttle trigger.

ⓘ IMPORTANT

When it doesn't stop at the stop switch, move the choke lever to the closed position.



ADJUSTING THROTTLE CABLE

The normal play is 1 or 2 mm when measured at the carburetor side end. Readjust with the cable adjuster as required and tighten the screw up.

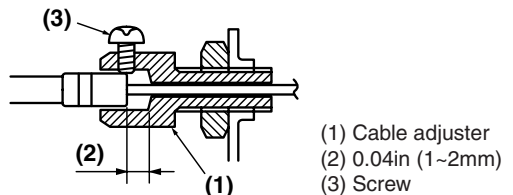

8. Operation

ADJUSTING IDLING SPEED

1. When the engine tends to stop frequently at idling mode, turn the adjusting screw clockwise.
2. When the cutting head keeps rotating after releasing the throttle trigger, turn the adjusting screw counter-clockwise.

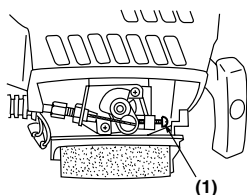

(1) Idle speed adjuster

NOTE

Warm up the engine before adjusting the idling speed.

ADJUSTING THE MAXIMUM SPEED

- The screw at the throttle lever is for adjusting the maximum rpm.
 - Turning the screw crock-wise, the rpm becomes down, the otherwise, the rpm becomes up. (STANDARD OPERATION SPEED: 8000 to 9500 rpm)
- Running engine with faster engine speed than 9500 rpm may damage the engine, slower engine speed than 8000 rpm may cause of the poor cutting ability.

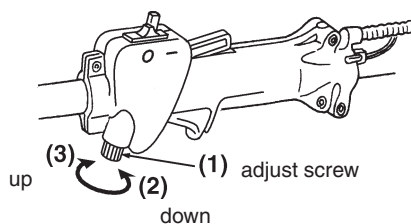

WARNING

- This product is equipped with extremely sharp blades, and when used improperly these blades can be extremely dangerous, and improper handling can cause accidents which may in turn lead to serious injury or death. For this reason, you should always be careful to follow the following instructions when using your trimmer.
- Never hold the trimmer in a way in which the blades are pointed towards someone else.
- Never allow the blades to come into proximity with your body while the engine of the trimmer is in operation.
- Always be sure to turn off the engine before changing the angle of the blades, removing branches which have become stuck in the blades, or at any other time when coming into close proximity with the blades.
- Always wear work gloves made of leather or some other sturdy material when using the trimmer.
- Always place the blade cover provided with the trimmer over the blades when not in use.
- Falling branches may fall onto the face or into the eyes,

resulting in injuries, scratches, and cuts, and for this reason you should always be sure to wear a helmet and face protector when using your trimmer.

NOTE

- The thickness of branches which may be cut using this trimmer is limited to up to approximately 4.8mm. Never try to cut branches thicker than this, as doing so may result in damage to the trimmer.

ADJUSTING THE ANGLE OF THE CUTTING BLADES

1. Stop the trimmer engine.
2. Turn the bolt located on the top of the transmission counter-clockwise to loosen it.
3. Adjust the angle of the blades to the desired angle, and then fix the bolt firmly back into place.

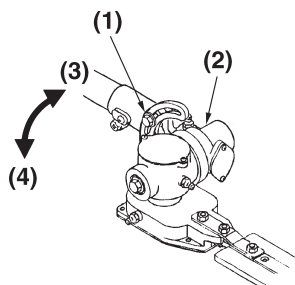

- (1) Clamp bolt
- (2) Transmission
- (3) Tighten
- (4) Loosen



9. Maintenance

MAINTENANCE CHART

	System/components	Procedure	Before use	Every 25 hours after	Every 50 hours after	Every 100 hours after	Note
ENGINE	fuel leaks, fuel spillage	wipe out	✓				
	fuel tank, air filter, fuel filter	inspect/clean	✓	✓			replace, if necessary
	idle speed adjuster	see adjusting idling speed	✓				replace carburetor if necessary
	spark plug	clean and readjust plug gap			✓		GAP: .025 in (0.6 ~ 0.7 mm) replace, if necessary
	intake air cooling vent	clean		✓			
SHAFT	throttle trigger, stop switch	check operation	✓				
	cutting attachment	replace if something's wrong	✓				
	transmission, cutter case	grease		✓			
	screws/nuts/bolts	tighten/replace	✓			✓	not adjusting screws

- **Before cleaning, inspecting, or repairing the unit, make sure that the engine has stopped and is cool.**
- **Use protective gloves whenever inspecting, removing, sharpening, and installing the blades.**

BLADES

- When refilling the tank or resting, it is often a good idea to use the time to oil the cutting blades.
 - If a gap exists between the upper and lower blades, follow the procedure below to adjust them so that they fit more closely together.
 - Loosen lock nut (A) as shown in the diagram.
1. Tighten screw (B) fully, and then turn one-third to one-half of a rotation backward.
 2. While holding onto the screw to keep it in position, tighten the lock nut.
 3. Check to make sure that the flat washer (C) is loose enough so that it may be turned by pressing on it with a finger.

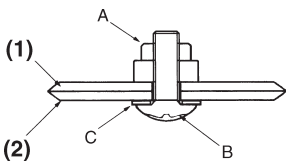

- (1) Upper blade
(2) Lower blade

NOTE

- Screwing in the screw too tightly may make it impossible for the blades to move. Conversely, not screwing in the screw tightly enough may make the blades of the trimmer feel dull and cause leaves and branches to become caught in the blades of the trimmer.

QUICK TIP

- If the blades become so worn down that it is no longer possible to eliminate the gap between them, you should contact the authorized ZENOAH servicing dealer from which you purchased your ZENOAH trimmer to have the blades resharpened or replaced.

TRANSMISSION

- The inside of the transmission should be lubricated using ZENOAH-approved lubricant after every 25 hours of use.
- When adding lubricant, use a grease gun to insert lubricant into the three grease nipples located on the transmission.

TYPE OF LUBRICANT TO BE USED

Always be sure to use #2 lithium heat-resistant lubricant.

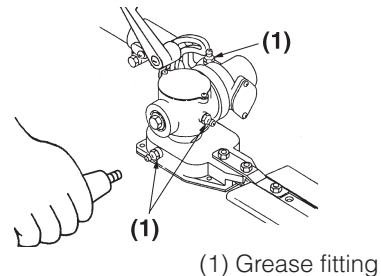

9. Maintenance

⚠ WARNING

Make sure that the engine has stopped and is cool before performing any service to the machine. Contact with moving cutting head or hot muffler may result in a personal injury.

AIR FILTER

- The air filter, if clogged, will reduce the engine performance. Check and clean the filter element in warm, soapy water as required. Dry completely before installing. If the element is broken or shrunk, replace with a new one.

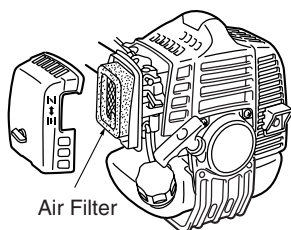

FUEL FILTER

- When the engine runs short of fuel supply, check the fuel cap and the fuel filter for blockage.

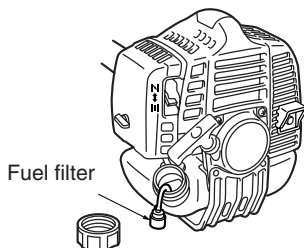

SPARK PLUG

- Starting failure and mis-firing are often caused by a fouled spark plug. Clean the spark plug and check that the plug gap is in the correct range. For a replacement plug, use the correct type specified by ZENOAH.

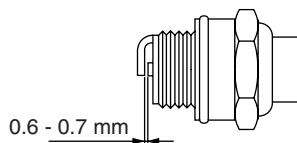

- REPLACEMENT PLUG IS A NGK CMR7H.

ⓘ IMPORTANT

- Note that using any spark plug other than those designated may result in the engine failing to operate properly or in the engine becoming overheated and damaged.
- To install the spark plug, first turn the plug until it is finger tight, then tighten it a quarter turn more with a socket wrench.

TIGHTENING TORQUE: 9.8 ~ 11.8 N.m.
(1 ~ 1.2 kg.m.)

MUFFLER

⚠ WARNING

- Inspect periodically, the muffler for loose fasteners, any damage or corrosion. If any sign of exhaust leakage is found, stop using the machine and have it repaired immediately in the repair specialty store.
- Note that failing to do so may result in the engine catching on fire.

SPARK ARRESTER

- The muffler is equipped with a spark arrester to prevent red hot carbon from flying out of the exhaust outlet. Periodically inspect and clean as necessary with a wire brush in the repair specialty store.

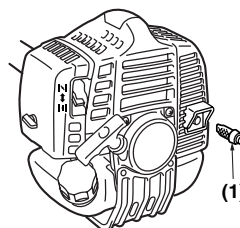

(1) Spark arrester

9. Maintenance

INTAKE AIR COOLING VENT

⚠ WARNING

- **Check the intake air cooling vent after every 25 hours of use for blockage, and remove any waste which has attached itself to the machine.**

❗ IMPORTANT

- If waste gets stuck and causes blockage around the intake air cooling vent, it may cause the engine to overheat, and that in turn may cause mechanical failure on the part of the machine.

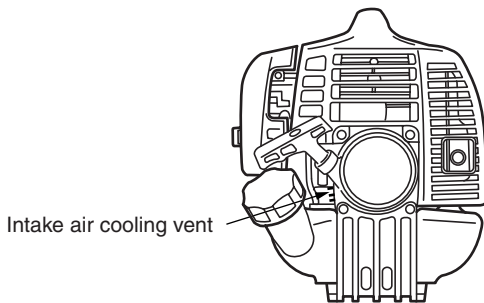

10. Storage

- Aged fuel is one of major causes of engine starting failure. Before storing the unit, empty the fuel tank and run the engine until it uses all the fuel left in the fuel line and the carburetor. Store the unit indoor taking necessary measures for rust prevention.
- Oil the blades.

11. Disposal

- When you dispose of the machine, do not disassemble the machine.
- When you dispose of the machine, fuel, oil, be sure to follow your local regulations.

12. Troubleshooting guide

Case 1. Starting failure

CHECK	PROBABLE CAUSES	ACTION
fuel tank	→ incorrect fuel	→ drain it and use correct fuel
fuel filter	→ fuel filter is clogged	→ clean
carburetor adjustment screw	→ out of normal range	→ adjust to normal range
sparkling (no spark)	→ spark plug is fouled/wet	→ clean/dry
	→ plug gap is incorrect	→ correct (GAP: 0.6 ~ 0.7 mm)
spark plug	→ disconnected	→ retighten

Case 2. Engine starts but does not keep running/hard re-starting

CHECK	PROBABLE CAUSES	ACTION
fuel tank	→ incorrect fuel or staled fuel	→ drain it and use correct fuel
carburetor adjustment screw	→ out of normal range	→ adjust to normal range
muffler, cylinder (exhaust port)	→ carbon is built-up	→ consult with the repair specialty store
air cleaner	→ clogged with dust	→ air blow or wash
cylinder fin, fan cover	→ clogged with dust	→ consult with the repair specialty store

When your unit seems to need further service, please consult with our ZENOAH service shop in your area.

Limited warranty

Should any failure occur on the product under normal operating conditions within the applicable warranty period, the failed part will be replaced or repaired free of charge by a ZENOAH authorized dealer.

WARRANTY PERIOD: 1 year (6 months if used professionally, and 30 days if used for rental purpose) from the date of initial purchase.

THE PURCHASER SHALL BEAR COSTS OF TRANSPORTING THE UNIT TO AND FROM THE ZENOAH DEALER.

THE PURCHASER SHALL NOT BE CHARGED FOR DIAGNOSTIC LABOR WHICH LEADS TO THE DETERMINATION THAT A WARRANTED PART IS DEFECTIVE, IF THE DIAGNOSTIC WORK IS PERFORMED AT THE ZENOAH DEALER.

THE PURCHASER OR OWNER IS RESPONSIBLE FOR THE PERFORMANCE OF THE REQUIRED MAINTENANCE AS DEFINED BY THE MANUFACTURER IN THE OWNER/OPERATOR MANUAL.

ANY WARRANTED PART WHICH IS NOT SCHEDULED FOR REPLACEMENT AS REQUIRED MAINTENANCE, OR WHICH IS SCHEDULED ONLY FOR REGULAR INSPECTION TO THE EFFECT OF REPAIR OR "REPLACE AS NECESSARY" SHALL BE WARRANTED FOR THE WARRANTY PERIOD. ANY WARRANTED PART WHICH IS SCHEDULED FOR REPLACEMENT AS REQUIRED MAINTENANCE SHALL BE WARRANTED FOR THE PERIOD OF TIME UP TO THE FIRST SCHEDULED REPLACEMENT POINT FOR THE PART.

ANY REPLACEMENT PART THAT IS EQUIVALENT IN PERFORMANCE AND DURABILITY MAY BE USED IN NON-WARRANTY MAINTENANCE OR REPAIRS, AND SHALL

NOT REDUCE THE WARRANTY OBLIGATION OF THE COMPANY.

THE COMPANY IS LIABLE FOR DAMAGES TO OTHER ENGINE COMPONENTS CAUSED BY THE FAILURE OF A WARRANTED PART STILL UNDER WARRANTY.

THE WARRANTY DOES NOT APPLY TO THOSE UNITS WHICH HAVE BEEN DAMAGED BY NEGLIGENCE OF INSTRUCTION LISTED IN THE OWNER/OPERATOR MANUAL FOR PROPER USE AND MAINTENANCE OF THE UNITS ACCIDENT MISHANDLING, ALTERATION, ABUSE, IMPROPER LUBRICATION, USE OF ANY PARTS OR ACCESSORIES OTHER THAN THOSE SPECIFIED BY THE COMPANY, OR OTHER CAUSES BEYOND THE COMPANY'S CONTROL.

THIS WARRANTY DOES NOT COVER THOSE PARTS REPLACED BY NORMAL WEAR OR HARMLESS CHANGES IN THEIR APPEARANCE.

THERE ARE NO OTHER EXPRESS WARRANTIES.

IMPLIED WARRANTIES INCLUDING THOSE OF MERCHANTABILITY AND FITNESS FOR A PARTICULAR PURPOSE **ARE LIMITED** TO TWO (2) YEARS OF HOME USE [ONE (1) YEAR FOR ANY OTHER USE] FROM THE ORIGINAL DELIVERY DATE.

LIABILITIES FOR INCIDENTAL OR CONSEQUENTIAL DAMAGE UNDER ANY AND ALL WARRANTIES ARE EXCLUDED.

IF YOU NEED TO OBTAIN MORE INFORMATION, PLEASE CALL YOUR NEAREST SERVICE CENTER, OR CHECK PLEASE ZENOAH WEB SITE

<http://www.zenoah.net>

