

Electrolux

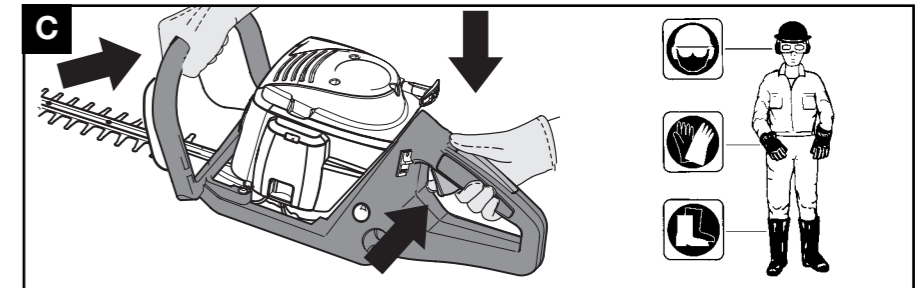
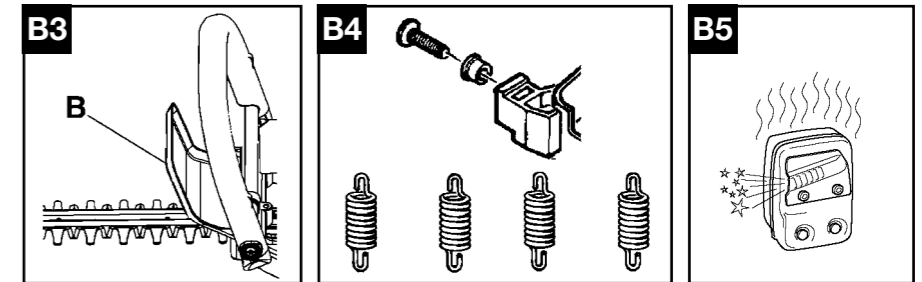
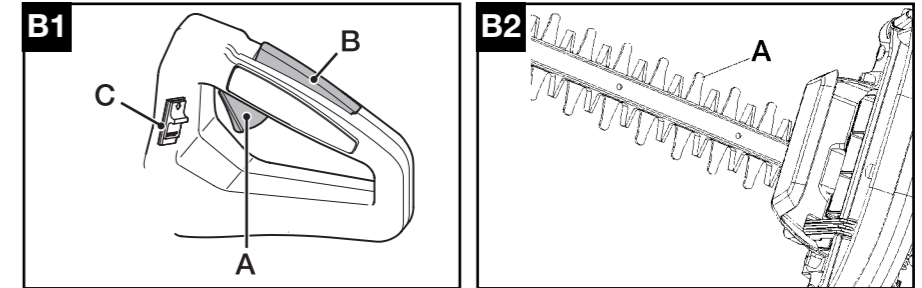
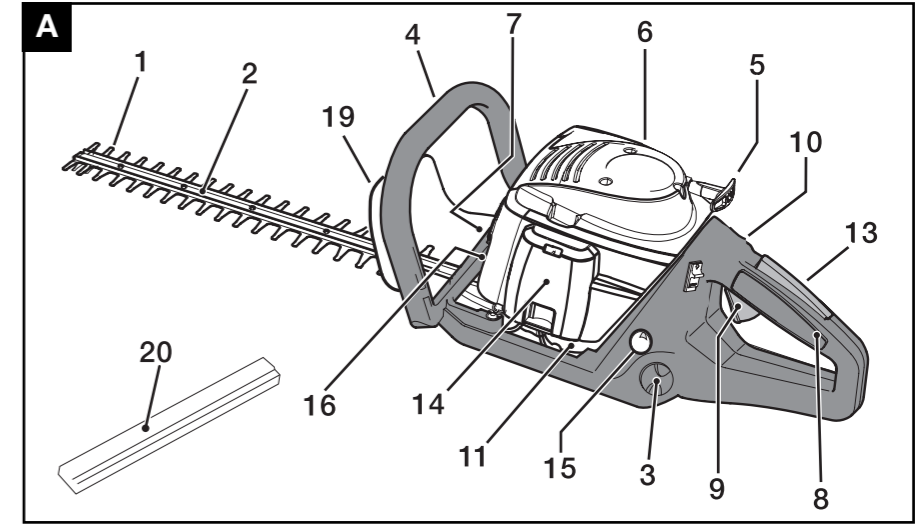
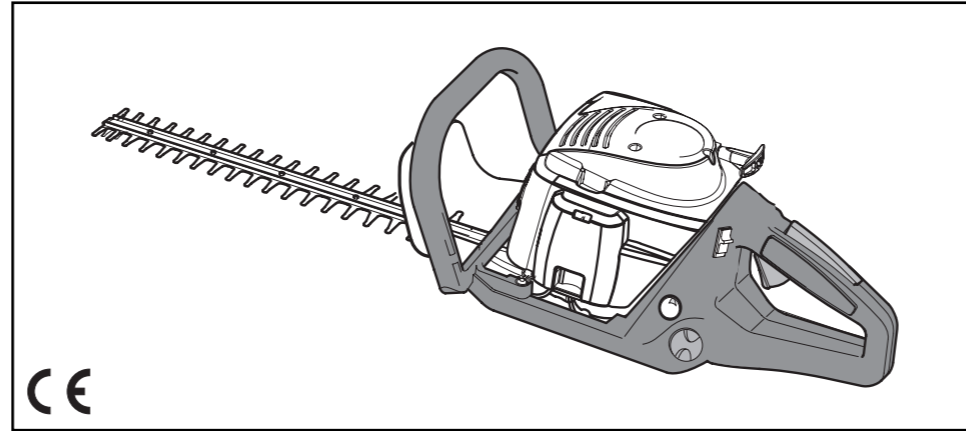

GB INSTRUCTION MANUAL
IMPORTANT INFORMATION: Please read these instructions carefully and make sure you understand them before using this unit. Retain these instructions for future reference.

DE BETRIEBSANWEISUNG WICHTIGE INFORMATION:
 Lesen Sie diese Hinweise zur Handhabung des Geräts aufmerksam durch. Verwenden Sie es erst, wenn Sie sicher sind, daß Sie alle Anweisungen verstanden haben und gut aufbewahren.

FR MANUEL D'INSTRUCTIONS RENSEIGNEMENTS IMPORTANTS: Avant d'utiliser cet appareil, veuillez lire attentivement les instructions et assurez-vous de les avoir comprises. Conservez les instructions pour référence ultérieure.

NL HANDLEIDING BELANGRIJKE IMPORTANTS: Lees deze handleiding aandachtig en zorg dat u alles begrijpt alvorens de kettingzaag te gebruiken en be-waar ze voor toekomstige raadpleging.

NO BRUKERHÅNDBOK
VIKTIG INFORMASJON: Les disse anvisningene nøye og forsikre deg om at du forstår dem før du bruker enheten og oppbevar dem for senere bruk.

FI OHJEKIRJA
TÄRKEÄÄ TIETOA: Lue nämä ohjeet huolellisesti ja varmista, että olet ymmärtänyt ne, ennen kuin alat käyttää tätä laitetta ja säilytä johyempää tarvetta varten.

SE BRUKSANVISNING
VIKTIG INFORMATION: Läs instruktionerna noggrant och försäkra dig om att du förstår dem innan du använder utrustningen och spara dem för framtida behov.

DK BRUGERHÅNDBOG
VIGTIGE OPLYSNINGER: Læs instruktionerne omhyggeligt, før du bruger enheden og gem dem til senere henvisning.

ES MANUAL DE INSTRUCCIONES
INFORMACIÓN IMPORTANTE: Lea atentamente las instrucciones y asegúrese de entenderlas antes de utilizar esta aparato. Conserve las instrucciones para la referencia en el futuro.

PT MANUAL DO OPERADOR
INFORMAÇÕES IMPORTANTES: Queira ler cuidadosamente estas instruções e tenha certeza de entendê-las antes de usar a serra e guarde para consulta futura.

IT LIBRETTO D'ISTRUZIONI
INFORMAZIONI IMPORTANTI: Leggere le istruzioni attentamente e capirle bene prima di usare l'utensile. Conservare per ulteriore consultazione.

HU HASZNÁLATI ÚTMUTATÓ
 Jótállást vállalni csak rendeltetésszerűen használatba vett gépekre tudunk. Kérj ú hogy a gép használatba vétele előtt gondosan olvassa el a kezelési utasításokat.

GR ΕΓΧΕΙΡΙΔΙΟ ΧΡΕΙΣΜΟΣ ΣΗΜΑΝΤΙΚΕΣ ΠΛΗΡΟΦΟΡΙΕΣ: Διαβάστε προσεκτικά αυτές τις οδηγίες και φροντίστε να τις κατανοήσετε αυτό το μηχάνημα και φυλάξτε το για να το συμβουλευέστε στο μέλλον.

CZ NÁVOD K POUŽÍVÁNÍ DŮLEŽITÁ INFORMACE!
 Než začnete stroj používat přečtěte si prosím velmi pozorně tyto instrukce a ujistěte se, že jste jim porozuměli. Ušchovejte si tento návod pro použití i v budoucnu.

PL INSTRUKCJA OBSŁUGI
 Gwarancja traci ważność w przypadku używania urządzenia do celów innych niż wymienione w instrukcji obsługi. Prosimy o uważne przeczytanie instrukcji oraz o stoowanie się do zaleceń i wskazówek w niej zawartych.

SK NÁVOD NA OBSLUHU Dôležitá informácia:
 Pred použitím stroja si starostlivo prečítajte tento návod na obsluhu a uistite sa že ste mu dôkladne porozumeli. Návod starostlivo uschovajte pre potrebu v budúcnosti.

RU ИНСТРУКЦИИ ВАЖНЫЕ СВЕДЕНИЯ:
 Внимательно прочитайте инструкции и хорошо их понять, перед тем как пользоваться блоком. Хранить инструкции для дальнейших консультаций.

EE KASUTUSJUHEND TÄHTIS INFORMATSIOON:
 Lugege kasutusjuhend enne seadme kasutamist kindlasti põhjalikult läbi ning veenduge, et olete kõigest täpselt aru saanud.

LV ROKASGRĀMATA SVARĪGA INFORMĀCIJA:
 Pirms ierīces izmantošanas uzmanīgi izlasiet rokasgrāmatu un pārliecinieties, ka jūs ļoti saprotat tās saturu. Saglabājiet rokasgrāmatu, lai nākotnē būtu iespējams atsvaidzināt jūsu zināšanas.

TR KULLANMA KYLAVUZU ÖNEMLİ TALİMATLAR:
 Buradaki bilgileri dikkatlice okuyunuz ve alet kullanmaya başlamadan önce tüm talimatların tarafınızdan anlaşılmiş olduğundan emin olunuz. Gerektiği zaman başvurabimimiz için saklayınız.

Electrolux Outdoor Products
 Via Como 72
 23868 Valmadrera (Lecco)
ITALIA

Phone +39 0341 203111 - Fax +39 0341 581671

Our policy of continuous improvement means that the specification of products may be altered from time to time without prior notice. Electrolux Outdoor Products manufacture products for a number of well known brands under various registered patents, designs and trademarks in several countries.

The Electrolux Group. The world's No.1 choice.

The Electrolux Group is the world's largest producer of powered appliances for kitchen, cleaning and outdoor use. More than 55 million Electrolux Group products (such as refrigerators, cookers, washing machines, vacuum cleaners, chain saws and lawn mowers) are sold each year to a value of approx. USD 14 billion in more than 150 countries around the world.

PN 249512 REV. 02 (03/05)



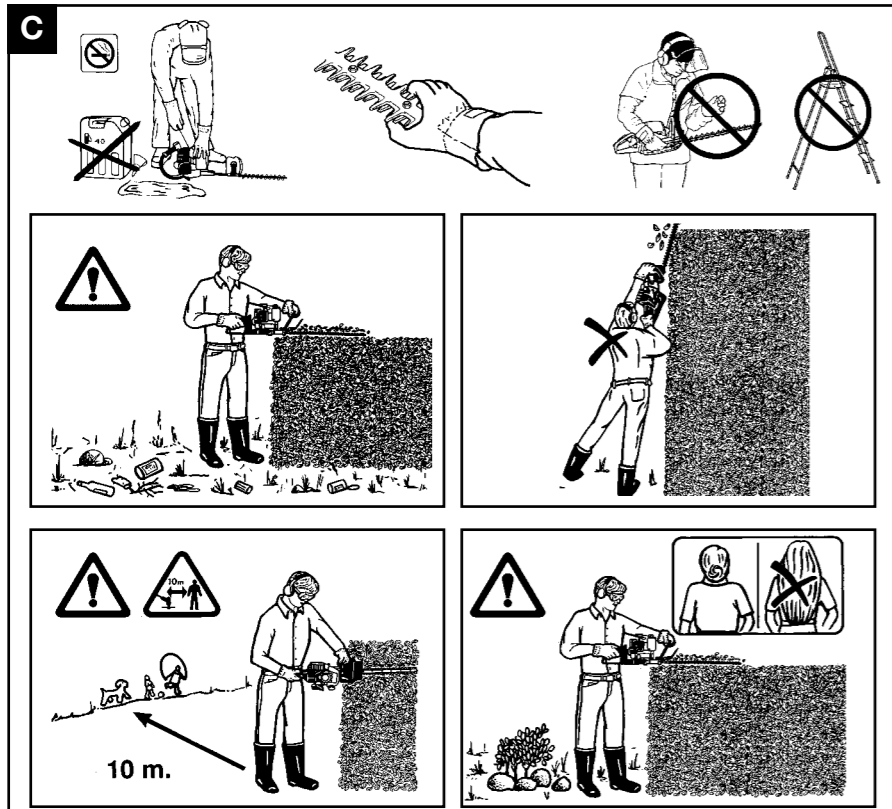

D

2 Strokes Engine totally sintetyc oil Partner oil		McCulloch oil	
50:1	2%	40:1	2,5%
1 ltr	20 cm ³	1 ltr	25 cm ³
5	100	4	100
10	200	5	125
15	300	10	250
20	400	20	500

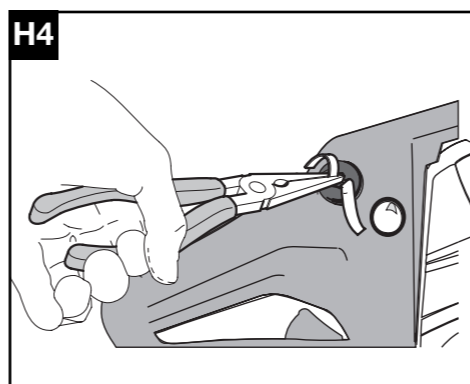
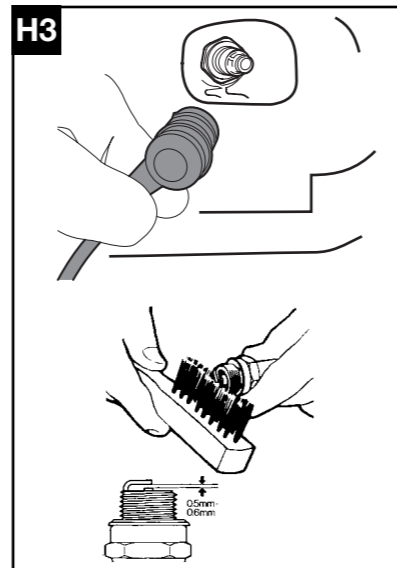
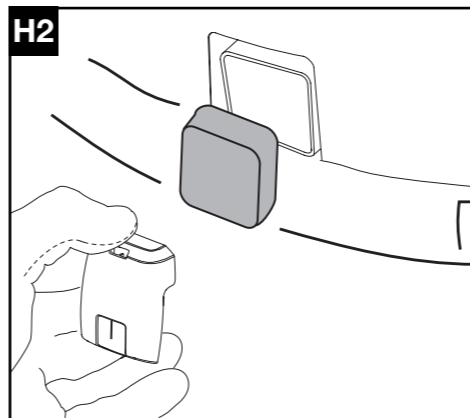
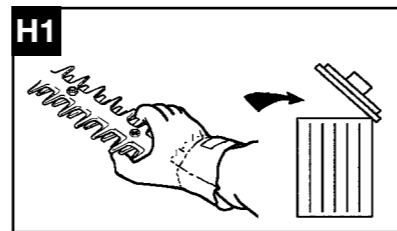
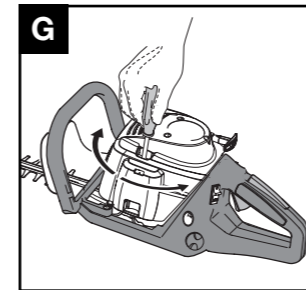
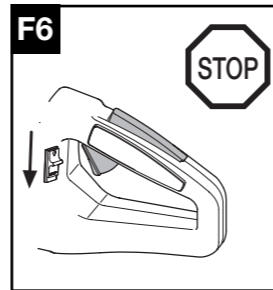
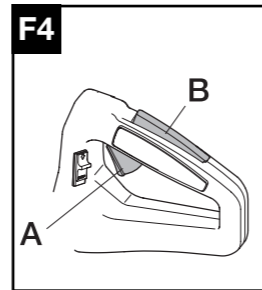
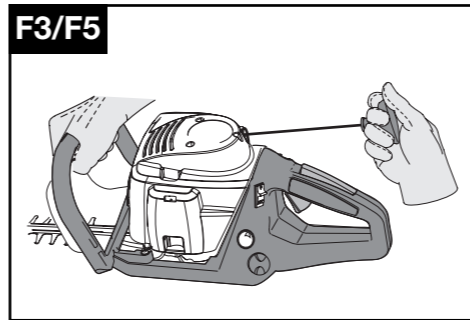
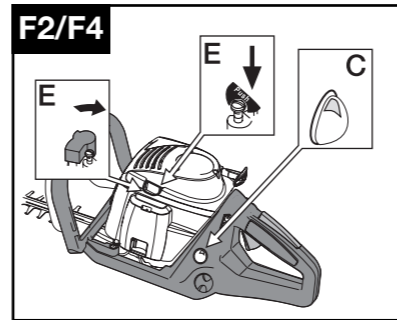
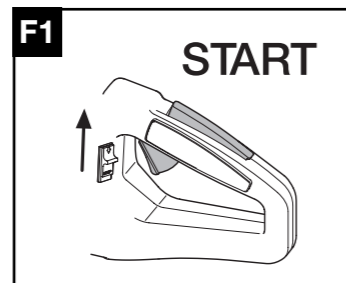
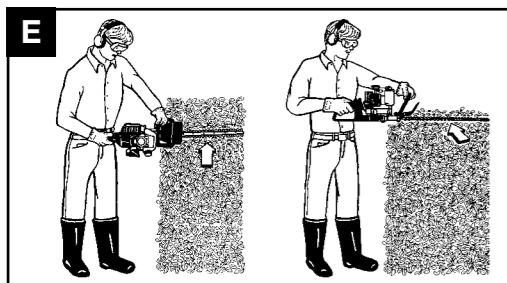

GB Due to a constant product improvement programme, the factory reserves the right to modify technical details mentioned in this manual without prior notice.

DE Im Sinne des Fortschritts behält sich der Hersteller das Recht vor, technische Änderungen ohne vorherigen Hinweis durchzuführen.

FR La Maison se réserve la possibilité de changer des caractéristiques et des données de ce manuel à n'importe quel moment et sans préavis.

NL Door konstante produkt ontwikkeling behoud de fabrikant zich het recht voor om rechnische specificaties zoals vermeld in deze handleiding te veranderen zonder hiervan vooraf bericht te geven.

NO Produsenten forbeholder seg all rett og mulighet til å forandre tekniske detaljer i denne manualen uten forhåndsvarsel.

FI Jatkuvan tuotteen parannusohjelman tähden valmistaja pidättää oikeuden vaihtaa ilman ennakkovaroitusta tässä ohjekirjasessa mainittuja teknisiä yksityiskohtia.

SE Tilverkaren reserverar sig rätten att ändra fakta och uppgifter ur handboken utan förvarning.

DK Producenten forbeholder sig ret til ændringer, hvad angår karakteristika og data i nærværende instruktion, når som helst og uden varsel.

ES La firma productora se reserva la posibilidad de cambiar las características y datos del presente manual en cualquier momento y sin previo aviso.

PT A casa productora se reserva a possibilidade de variar características e dados do presente manual em qualquer momento e sem aviso prévio.

IT La casa produttrice si riserva la possibilità di variare caratteristiche e dati del presente manuale in qualunque momento e senza preavviso.

HU A gyártó cég fenntartja a jogot arra, hogy a használati utasításban megadott adatokon és technikai tulajdonságokon bármikor és előzetes bejelentés nélkül változtasson.

GR Λόγω προγράμματος συνεχοῦς βελτίωσης προϊόντων, το εργοστάσιο επιφυλάσσει του δικαιώματος να τροποποιεί τις τεχνικές λεπτομέρειες που αναφέρονται στο εγχειρίδιο αυτό χωρίς προηγούμενη ειδοποίηση.

CZ Vzhledem k pokračujícím inovacím si výrobce vyhrazuje právo měnit technické hodnoty uvedené v této příručce bez předchozího upozornění.

PL W związku z programem ciągłego ulepszania swoich wyrobów, producent zastrzega sobie prawo do wprowadzania zmian w szczególach technicznych wymienionych w tej instrukcji bez uprzedniego zawiadomienia. Instrukcja jest częścią wyposażenia.

SK Proizvavalec si pridružuje pravico, da spremeni značilnosti in podatke pričujočega priročnika v katerem koli trenutku in brez predhodnega obvestila.

RU Компания производитель сохраняет за собой право изменять характеристики и данные в настоящем руководстве, в любой момент и без предварительного извещения.

EE Tootja jätab endale õiguse muuta käesolevas kasutusjuhendis kirjeldatud omadusi ja andmeid suvalisel hetkel ja sellest eelnevalt ette teatamata.

LV Izgatavotājs saglabā tiesības jebkurā brīdī un bez brīdinājuma mainīt šajā rokasgrāmatā esošos datus un raksturlielnes.

TR Üretici firma bu kullanma kılavuzunda yer alan özellikler ve verilerin istediği zamanda ve haber vermeksizin değiştirilme hakkını kendinde sahip tutar.

A. General Description

- | | |
|---|--|
| <ol style="list-style-type: none"> 1) BLADES 2) BLADE GUIDE 3) FUEL CAP 4) FRONT HANDLE 5) STARTER HANDLE 6) CYLINDER COVER 7) SPARK PLUG 8) HANDLE 9) THROTTLE CONTROL TRIGGER 10) STOP SWITCH | <ol style="list-style-type: none"> 11) GEAR BOX 12) GREASE GUN 13) SAFETY LEVER 14) AIR FILTER 15) CHOKE CONTROL 16) FUEL ENRICHMENT LEVER 17) HANDLE LOCK KNOB 18) FRONT HANDLE LOCK LEVER 19) HAND GUARD 20) TRANSPORT GUARD |
|---|--|

PRODUCT IDENTIFICATION LABEL

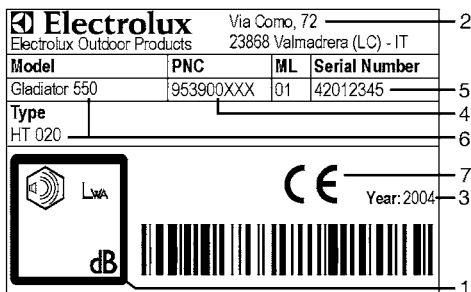
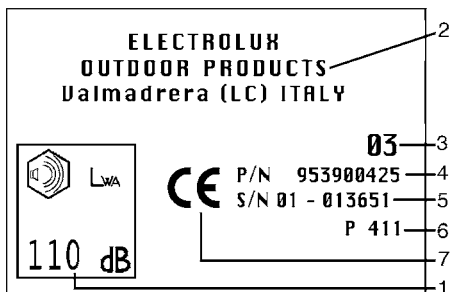

<p>LEGEND:</p> <ol style="list-style-type: none"> 1) Guaranteed noise level according to directive 2000/14/EC 	<ol style="list-style-type: none"> 2) Manufacturer's name and address 3) Year of manufacture (last two figures; e.g. 03=2003) 	<ol style="list-style-type: none"> 4) Product code 5) Serial no. 6) Model/type 7) CE seal of conformity
---	---	---

Safety precautions



CAUTION!

- Use the hedge trimmer properly in order to avoid injuries.
 - Follow the instructions and precautions for reasonably safe, efficient use of the product.
 - It is the responsibility of the user to follow the instructions and precautions provided in the manual supplied with the product.
- Note the illustrations at the beginning of the manual. Every section of the text in the manual refers to the illustration bearing the same letter**

Key to symbols



Warning



Read the instructions for the user carefully and make sure you understand how all the controls work.



Safety apparel:
Approved protective goggles or visor, approved hard hat and hearing protection



Safety apparel:
Approved gloves



Safety apparel:
Approved boots



Do not smoke when
refueling or using the
machine



Fuel enrichment (starting
aid).

B. Description of the safety devices on the machine, Controls and maintenance necessary to ensure safe conditions



WARNING! Never use the machine for any reason with its safety devices out of order

- This section describes the safety devices installed on the machine, the controls and maintenance to perform to keep them in perfect working order.
- The general description section will help you to identify the parts described in this section.
- The risk of accidents is greatly increased if maintenance is not performed regularly or is not performed professionally. In case of doubts, contact an authorized service center.

B1 Safety lever

- This device was developed to prevent accidental pressing of the throttle control trigger A. The trigger A only works if it is pressed at the same time as the safety lever B. When the handle is released, two separate springs return the throttle trigger A and the safety lever B automatically to their original positions.

B1 Stop button

- When the Stop button C is pressed in the direction indicated by the symbol, the engine shuts down.
- To check correct operation, start the engine and make sure it shuts down when the Stop button C is switched to the Stop position.

B2 Blade guide

- The blade guide (A) is an important device developed to prevent accidental contact between parts of the body and the blades.
- Periodically, check the conditions of the device and have it replaced, if necessary, by an authorized service center.

B3 Hand guard

- The hand guard (B) prevents any accidental

contact of the hands with the blade unit.

- Periodically, and always after any violent impact to the guard, check its conditions.

B4 Vibration damping system

- The vibration damping system reduces the transfer of vibrations by means of springs and shock absorbers in rubber located between the engine/blades and the handles on the machine.
- Check regularly that the springs and rubber shock absorbers are properly mounted and do not exhibit any cracks or distortion.

B5 Muffler

- The muffler is designed to keep noise levels to a minimum and to direct the engine exhaust fumes away from the user.
- Comply with the following procedures for safe use of the hedge trimmer.

- **⚠ CAUTION!** The muffler can get very hot during use and remain so for some time after stopping. Contact of the area around the muffler can result in burns to the skin.

- **⚠ Remember the risk of fire. Make sure the muffler is always correctly fastened to the machine. Never use the machine with a defective or damaged muffler.**

- **⚠ CAUTION!** Engine exhaust fumes contain carbon monoxide which can cause poisoning. For this reason, you should not use the machine indoors.

- **⚠ CAUTION!** Engine exhaust fumes can get very hot and may contain sparks. Do not use it near inflammable material

C. SAFETY INSTRUCTIONS

General precautions

- Use the product only for the purpose for which it was designed.
- Do not use this machine for any other purpose than trimming or edging shrubs, hedges or bushes.
- Always grip the machine firmly with both hands.
- Make sure you know how to stop the engine and blades if necessary (see section on starting and stopping the engine).
- CAUTION! The blades of the hedge trimmer continue to move due to inertia even after the engine has been switched off, so be very careful of your hands as there is a real danger of amputation of the fingers.
- Inspect the machine carefully prior to using it.
- Make sure there are no loose screws, damaged parts or fuel leakage.
- THE ENGINE EXHAUST FUMES ARE POISONOUS TO BREATHE AND MAY CAUSE ASFIXIATION AND DEATH
- Never allow children to use this machine.
- Never allow children or persons who are not familiar with these instructions and sufficiently trained to use the hedge trimmer. Local regulations may indicate age limits for use.
- Anyone who uses the machine should be familiar with the instructions for safe use of it as described in this manual, and should be instructed in the proper cutting techniques to use, possibly by practical demonstration.
- Keep this manual with the machine when selling or lending it to others so that the future users can familiarize themselves with the product and the instructions for safe use.
- Wear properly fitting protective working clothes of approved type. Wear non-slip footwear, gloves, glasses and hearing protection.
- Do not wear loose clothing and jewelry that could catch in the moving parts of the machine.
- Keep hair fastened or gathered so that it does not hang below shoulder level.
- Examine the work area and be careful of any hazards (such as roads, driveways, power lines, hanging tree limbs, etc.).
- Remove any rubbish or refuse from the work area such as cans, bottles, rocks, etc.
- Any contact of the blades with other objects could cause serious injury to the operator, other people or animals in the vicinity and the machine.
- Never try to use a machine with any of its parts missing or after any alterations have been made to it by persons other than authorized service personnel.
- The operator or user is liable for any accidents

- or damages to third parties or property, and for the dangers to which they may be exposed.
- Take account of any hazard that may not be perceived because of the noise of the machine.
- Make sure there is someone in the vicinity within safe calling distance in case of any accidents.
- Never use the machine when you are or under the influence of any substances like drugs or alcohol that could affect your physical conditions.
- When you transport the hedge trimmer in a motor vehicle, place it in a stable fixed position so that no fuel leaks out.
- During transportation or storage of the machine always fit the blade guard on the blades to prevent accidental injury.
- ALWAYS USE ORIGINAL REPLACEMENTS AND ACCESSORIES.

Precautions for safe use of the machine

- Make sure any other persons or animals in the vicinity are at a safe distance (at least 10 meters). If necessary, use warning signals to keep persons and animals at a safe distance.
- If any fuel is spilled on the machine, make sure the engine is completely dry before starting it.
- Keep the grips clean and dry
- Never start the machine if the blades are damaged or badly worn
- If you wear the Electrolux safety visor, make sure to remove the transparent protective film, if any.
- Keep all parts of the body and clothing away from the blades during startup and while the engine is running.
- Always work from a stable position on your feet.
- Do not use the hedge trimmer while standing on a ladder or other unstable support.
- When trimming tall hedges or bushes, use a stable, safe platform and stand in a stable position without the risk of losing your balance.
- If you strike an object accidentally, switch off the engine immediately and examine the machine.
- Make sure the grip and hand guard are in place during use of the machine.
- When trimming or edging, keep the engine running at high speed; these operations should not be carried out with the motor running at low speed.
- Never lift the hedge trimmer above shoulder height when using it.
- Always wait for the motor to idle before moving the machine from one section of the shrub or hedge to another.
- Stop the engine when changing to another place or before examining the blades.

- Before starting to cut again make sure your position is correct.
- To reduce the fire hazard keep the engine and muffler free of twigs, leaves or excess lubricant.
- Watch out for the sharp edges and hot part of the machine.
- Prolonged use of the machine or other equipment expose the operator to vibrations that can cause the White Finger Syndrome (Syndrome of

Raynaud). This could reduce the sensitivity of the hands in distinguishing different temperatures and cause a general numbness. The operator should therefore check the conditions of the hands and fingers if the machine is used continuously or regularly. If one of the symptoms should appear, consult a doctor immediately.

D. Fuel Mixture

 **CAUTION!** Do not smoke while refueling!

- Open the cap on the tank by loosening it slowly.
- Fill the tank in the open, far from flames or sparks.
- Never add fuel in the tank when the engine is running or hot, (let the engine cool off before filling the tank) to avoid the risk of fire.
- Avoid contact of the oil and fuel with the skin and eyes.
- Fill the tank in a well-ventilated place.
- Do not inhale the fumes of the fuel mixture. It is toxic.
- Store the fuel mixture in suitable fuel containers only.

PREPARATION OF THE MIXTURE

 **CAUTION!**

- Do not use any other type of fuel than the type recommended in this manual.
- This machine is equipped with a two-stroke engine and should therefore be fueled with a mixture of unleaded gasoline (with a minimum octane rating = 90) and fully synthetic oil specific for two-speed engines that use unleaded gasoline in the proportions indicated in the table on the cover, fig. (D)

 **CAUTION!** Control the specifications of the oil shown on the package; the use of oil lacking the specifications expressly indicated in this manual could cause serious damage to the engine!

- To obtain the best mixture, pour the oil into an approved container first, followed by the gasoline, and shake the container well (every time you take fuel out of it).

- Be careful not to spill the gasoline.
- The characteristics of the mixture tend to deteriorate in time, so you should only prepare as much mixture as you are going to need.

FILLING THE TANK

 **CAUTION!** The following precautions should be taken to reduce the fire hazard:

- Always ensure there is adequate ventilation.
- Do not smoke or take sources of heat or sparks near the fuel.
- Refuel with the engine off.
- Open the cap on the tank carefully to eliminate any excess pressure.
- Do not take the cap off the tank with the engine running.
- After fueling, close the cap tightly.
- Fill the tank in a well-ventilated place.
- Place the machine on a solid flat surface so that it cannot tip over, with the cap on the tank facing upward.
- Clean the area around the fuel cap before removing it, to prevent any impurities from contaminating the fuel.
- Take the cap off the fuel container carefully. Unscrew the cap on the fuel tank and fill it with the necessary quality, using a funnel.
- Take care not to spill any fuel.
- After filling the tank, screw the cap on tightly.

 **CAUTION!** If you spill any fuel, wipe it off the machine. If you have spilt it on yourself, change your clothes at once. Avoid contact with the skin or eyes.

 **CAUTION!** The muffler gets very hot during use and remains hot for some time after switching off the engine. This also applies at idle speed. Take every precaution to reduce the fire hazard, especially in the presence of inflammable materials or gas.

FUEL STORAGE

- Gasoline is highly inflammable.
- Before going near any type of fuel, put out your cigarette, pipe or cigar.
- Store the fuel in a cool, well-ventilated place, in an approved fuel storage container.
- Never store the engine with fuel in the tank in a poorly ventilated place where the fumes pro-

duced by the gasoline could propagate and reach a fire, candle, burner or furnace pilot light, water heater, dryer, etc.

- The fumes produced by the fuel can cause an explosion or fire.
- Never store excessive quantities of fuel.
- To prevent problems in starting the engine again, we recommend that you never let the machine run completely out of fuel.

E. Cutting procedure



CAUTION! Wear heavy gloves of the approved type!

There are two possible cutting procedures with this machine:

- 1 Horizontal
- 2 Vertical

- 1 The horizontal cutting position is used to even the tops of bushes, shrubs and hedges.
 - Always cut from right to left.
 - Never use the hedge trimmer above shoulder height.

- 2 The vertical cutting procedure is used to trim the sides of shrubs, bushes and hedges.

- Always cut upward from the bottom.
- Hold the machine with both hands.
- Press the trigger of the butterfly valve all the way during cutting operations.
- When you have finished, release the trigger on the butterfly valve and wait for the engine to idle; the blade should stop.
- Move on to the next section.
- After reaching the next section and taking a stable standing position, resume working by pressing the trigger on the butterfly valve all the way down.

F. Starting and stopping the engine



CAUTION!

- Before starting the machine read this manual in its entirety, with special attention to the safety devices and recommended personal protection equipment.
- Before starting the machine make sure it is in perfect conditions and that all the safety devices are correctly installed and in perfect working order. Inspect the blades carefully and do not use the machine with worn or damaged blades, or if they exhibit noticeable cracks.
- Make sure all the covers are correctly installed
- Make sure the parts of the gear box and its lid are correctly mounted. Starting a machine without mounting these parts correctly could cause serious personal injury

- Place the machine on the ground in a flat, stable position
- Grasp the starter knob with one hand and use the other to hold the machine steady on the ground (Note: do not wind the starter cord around your hand) and pull gently until you feel some resistance, then pull the cord sharply and forcefully (to start the engine when warm or cold see the instructions below).



CAUTION!

Do not pull the starter cord all the way to the limit and do not let it snap back against the machine as this could damage it.

COLD ENGINE

- 1 Place the stop switch on "I" or "START"
- 2 Turn the fuel enrichment lever (E) to the closed position. Press the air purge diaphragm repeatedly until fuel begins to fill the diaphragm (C). The diaphragm need not be completely filled.
- 3 Pull the cord until the engine starts.



CAUTION!

To start the machine correctly and safely, use the following procedure:

- 4 Grasp the control grip firmly and accelerate, automatically the enrichment lever will return to its original position.
- 6 To stop the engine press the stop switch to bring it to the "0" or "STOP" position.

WARM ENGINE

- 1 Place the stop switch on "I" or "START"
- 4 Enrichment lever (E) in original position.
- 5 Pull the cord until the engine starts.
- 6 To stop the engine press the stop switch to bring it to the "0" or "STOP" position.

G. Carburetor adjustment



Your machine can be equipped with a low emission carburetor. We recommend that carburetor adjustment be done, if necessary, exclusively by authorized service centers, which have the appropriate equipment to ensure optimum performance with lower emissions.

- The correct engine setting at idle speed is 2800 rpm as indicated in the technical specifications of this manual and should not be modified unless by an authorized service center
- If the engine does not hold the idle speed, turn the screw T clockwise to increase the rpm and counterclockwise reduce the rpm.

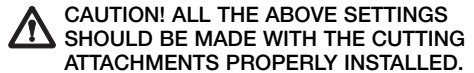

H. Routine Maintenance



- Do not make any repairs or adjustments on the machine that are not described in this manual.
- Contact an authorized service center if you have any questions about the repairs to make.
- The warranty may be invalidated in case of improper adjustments made by unauthorized persons not employed by authorized service centers.
- Place the Stop Switch (10) in the STOP position before making any adjustments on the machine
- always inspect the machine carefully before use.

1 BLADES

- Before starting the machine check the state of wear and conservation. In case of excessive wear take the unit to a service center for replacement.
- Caution: the blades are sharp and dangerous even with the engine off. Handle with care and use suitable protective gloves.

2 CLEANING OF AIR FILTER (At least every 25 hours of use).

- Use a screwdriver to lift and remove the air filter from its housing (see figure).

- Clean the filter with gasoline.
 - Dry the filter with air.
 - Reassemble the filter in its housing.
- NOTE: Replace the filter if torn or damaged.**

3 GREASING GEARBOX (Only for specific models)

- Every 50 hours of operation add grease to the gearbox for the high speed gears, through the inlet (C).

4 SPARKPLUG

- Periodically (at least once every 50 hours) disassemble and clean the sparkplug and adjust the spacing between the electrodes (0.5 – 0.6 mm).
- Replace if excessively worn or, in any case, after 100 hours of use.
- In case of excessive encrustation, check the carburetor adjustment, the proper percentage of oil in the fuel mixture and make sure the oil is high quality two-stroke engine motor oil.

5 FUEL FILTER

- For cleaning or replacement, remove the cap on the tank and extract the filter using a hook or long-nosed pliers.
- Periodically, at the beginning of the season, take the machine to your service center for general maintenance and cleaning of the internal parts.

- This will reduce the risk of unexpected problems and will guarantee the long life and good working order of your machine.

the cylindrical cover and fins on the cylinder using a wooden scraper.

REGULARLY:

- Important, to avoid overheating the engine, clean off any dust and dirt from the vents on



PROLONGED DISUSE:

Empty the fuel tank and run the engine until all the residual fuel is consumed.

Troubleshooting table

	The engine does not start	The engine stutters or loses power	The machine starts but does not cut properly
Make sure the STOP switch is on I.	●		
Make sure that the fuel tank is at least 25% full.	●	●	
Make sure the air filter is clean.	●	●	
Remove the sparkplug, dry and clean it, then return it to its place. If necessary, replace it.	●	●	
Change the fuel filter. Contact your supplier.		●	
Make sure the metal accessories are sharp, and contact your supplier if necessary.			●

The engine continues to have problems: contact your authorized supplier.

Environmental information

This section contains information useful for maintaining the characteristics of eco-compatibility included in the origin design of the machine, and as regards proper use and disposal of oil and fuel.

1. DESIGN

In the design stage, care was taken to develop an engine with reduced consumption and low emissions of noise and pollutant exhaust fumes.

2. USE OF MACHINE

The operations of filling the tank with the fuel mixture should be carried out in such a way as to avoid spilling fuel and contaminating the soil and environment.

3. PERIODS OF PROLONGED DISUSE

Always empty the fuel tank with the same precautions used in filling it.

4. DISPOSAL

Do not dispose inappropriately of the machine when it is no longer usable. Deliver it to an authorized organization for proper disposal in compliance with the regulations in force.

Conformity certificate

The undersigned, authorized by E.O.P., declares that the following products model /TYPE: **HT020** starting from the serial numbers produced from 2004 on, manufactured by E.O.P., Valmadrera, Italia, comply with European Directive: 98/37/EEC (Machine Directive), 93/68/EEC (EEC Marking Directive) & 89/336/EEC (Electromagnetic Compatibility Directive), directive 2000/14/EEC (Enclosure V).



Valmadrera, 15.10.04
Giuseppe Todero (Technical Manager)
Electrolux Outdoor Products Italy S.P.A.
Via Como 72, 23868 Valmadrera (Lecco) ITALY

Technical specifications

Cylinder displacement (cm ³)	25
Cylinder bore (mm)	35
Stroke (mm)	26
Power (kW)	0,7
Max cutting frequency (min ⁻¹)	2150
Max engine output (min ⁻¹)	8500
Idle speed (min ⁻¹)	2800
Dry weight (kg)	4,5
Fuel tank capacity (cm ³)	370
Noise level perceived by operator L _{P,av} dB(A) (ISO 11201)	95,6
Measured noise level L _{W,av} dB(A) (ISO 3744)	106
Guaranteed noise level L _{W,av} dB(A) (ISO 3744)	108
Vibrations on rear grip (m/s ²) (ISO 8662-1)	8
Vibrations on front grip (m/s ²) (ISO 8662-1)	8