



OWNER'S MANUAL

POLE SAW



PSZ2600

Original Language

⚠ WARNING ⚠

 Before using our products, please read this manual carefully to understand the proper use of your unit.

▲ SAFETY FIRST

Instructions contained in warnings within this manual marked with a ▲ symbol concern critical points which must be taken into consideration to prevent possible serious bodily injury, and for this reason you are requested to read all such instructions carefully and follow them without fail.

WARNINGS IN THE MANUAL

▲ WARNING

This mark indicates instructions, which must be followed in order to prevent accidents, which could lead to serious bodily injury or death.

❗ IMPORTANT

This mark indicates instructions, which must be followed, or it leads to mechanical failure, breakdown, or damage.

📖 NOTE

This mark indicates hints or directions useful in the use of the product.



This pole-mounted powered pruner (hereafter called pruner) is designed especially for tree service by a trained operator. For safe operation, you must read and understand this owner's manual completely before operating the pruner.

Note: Illustrations and specifications in this manual may vary according to requirements of individual countries and are subject to change without notice by the manufacturer.

Contents

1. Parts location	2
2. Specifications	3
3. Warning labels on the machine	3
4. Symbols on the machine	3
5. For safe operation	4
6. Set up	7
7. Fuel and chain oil	8
8. Operation	9
9. Maintenance	12
10. Storage	15
11. Disposal	15
12. Troubleshooting guide	15

1. Parts location

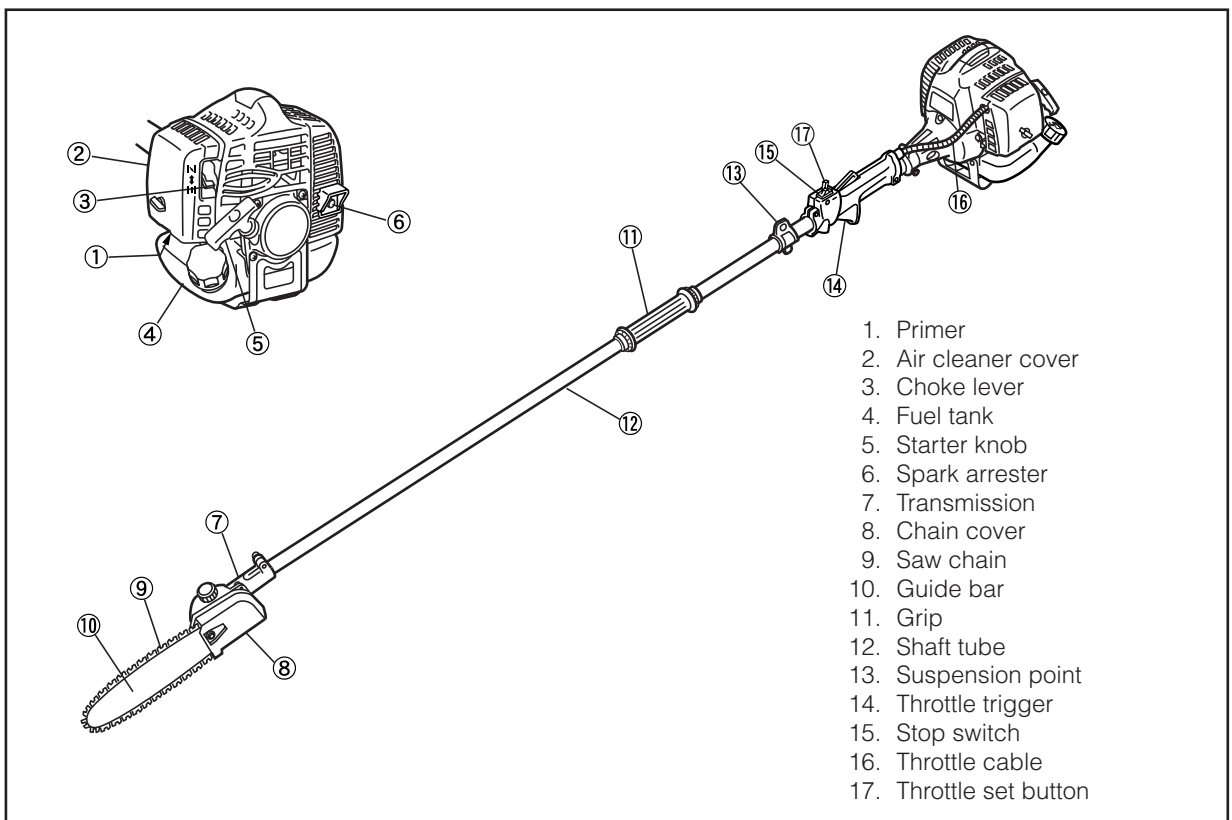

1. Primer
2. Air cleaner cover
3. Choke lever
4. Fuel tank
5. Starter knob
6. Spark arrester
7. Transmission
8. Chain cover
9. Saw chain
10. Guide bar
11. Grip
12. Shaft tube
13. Suspension point
14. Throttle trigger
15. Stop switch
16. Throttle cable
17. Throttle set button

2. Specification

PSZ2610

Overall size (L x W x H).....	2085 x 250 x 310mm
Dry weight	5.40kg
Engine Type	Air-cooled 2-stroke gasoline
Model	Zenoah GZ25N
Displacement	25.4cm ³
Max. output..	1.2Hp (0.9kW) at 7500min-1(rpm)
Idle speed	3000±200min-1(rpm)
Fuel	Mixture (Gasoline 50 : Oil 1) (when using ZENOAH genuine oil)
Carburetor	Walbro Diaphragm type
Spark plug	NGK CMR7A
Fuel tank capacity	0.65ℓ
Transmission	Centrifugal clutch, Rigid power transmission shaft
Reduction ratio	0.94

Cutting head	
Guide bar Type	OREGON DOUBLE GUARD
Size	10(25) in.(cm)
Saw chain Type	OREGON 90SG39X
Pitch x Gauge .	3/8x0.043 (9.53 x 1.07) in.(cm)
Sprocket	7T
Oil pump	Plunger type
Standard Accessories	
Harness	1 pc.
Tool Kit	1 pc.
Guide bar cover	1 pc.

Specifications are subject to change without notice.

3. Warning labels on the machine

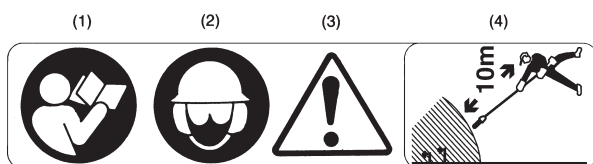

- (1) **Read owner's manual before operating this machine.**
- (2) **Wear head, eye and ear protection.**
- (3) **Warning/Attention**
- (4) **The unit has not been designed to provide protection from electric shock in the event of contact with overhead electric lines.**



If warning label peels off or becomes soiled and impossible to read, you should contact the dealer from which you purchased the product to order new labels and affix them in the required location(s).



Never modify your machine.
We won't warrant the machine, if you use the remodeled pruner or if you don't observe the proper usage written in the manual.

4. Symbols on the machine

For safe operation and maintenance, symbols are carved in relief on the machine. According to these indications, please be careful not to make a mistake.



The port to refuel the "MIX GASOLINE"
Position: FUEL TANK CAP



The direction to close the choke
Position: AIR CLEANER COVER



The direction to open the choke
Position: AIR CLEANER COVER



If you turn the rod by screwdriver follow the arrow to the "MAX" position, the chain oil flow more, and if you turn to the "MIN" position, less.

Position: Bottom of the TRANSMISSION

▲ 5. For safe operation



1. Read this manual carefully until you completely understand and follow all safety and operating instructions.
2. Keep this manual handy so that you may refer to it later whenever any questions arise. Also note, if you have any questions which cannot be answered herein, contact the dealer from whom you purchased the product.
3. Always be sure to include this manual when selling, lending, or otherwise transferring the ownership of this product.
4. Never allow children or anyone unable to fully understand the directions given in the manual to use the machine.



WORKING CONDITION

1. When using the product, you should wear proper clothing and protective equipment.

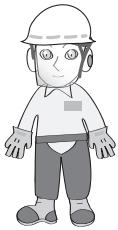

- (1) Helmet
- (2) Ear protectors
- (3) Protection goggles or face protector
- (4) Thick work gloves
- (5) Non-slip-sole work boots

2. And you should carry with you.
 - (1) Attached tools
 - (2) Properly reserved fuel
 - (3) Spare blade
 - (4) Things to notify your working area (rope, warning signs)
 - (5) Whistle (for collaboration or emergency)
 - (6) Hatchet or saw (for removal of obstacles)



3. Do not wear loose clothing, jewelry, short trousers, sandals, or go barefoot. Do not wear anything which might be caught by a moving part of the unit. Secure hair so it is above shoulder length.

WORKING CIRCUMSTANCE

1. Never start the engine inside a closed room or building. Exhaust gases contain dangerous carbon monoxide.
2. Never use the product,
 - a. when the ground is slippery or when you can't maintain a steady posture.
 - b. At night, at times of heavy fog, or at any other times when your field of vision might be limited and it would be difficult to gain a clear view of the working area.
 - c. During rain storms, during lightning storms, at times of strong or gale-force winds, or at any other times when weather conditions might make it unsafe to use the product.



WORKING PLAN

1. You should never use the product when under the influence of alcohol, when suffering from exhaustion or lack of sleep, when suffering from drowsiness as a result of having taken cold medicine or at any other time when a possibility exists that your judgment might be impaired or that you might not be able to operate the product properly and in a safe manner.
2. When planning your work schedule, allow plenty of time to rest. Limit the amount of time over which the product is to be used continuously to somewhere around 30 - 40 minutes per session, and take 10 - 20 minutes of rest between work sessions. Also try to keep the total amount of work performed in a single day under 2 hours or less.



▲ WARNING

1. If you don't observe the working time, or working manner (See "USING THE PRODUCT"), Repetitive Stress Injury (RSI) could occur. If you feel discomfort, redness and swelling of your fingers or any other part of your body, see a doctor before getting worse.
2. To avoid noise complaints, in general, operate product between 8 a.m. and 5 p.m. on weekdays and 9 a.m. to 5 p.m. on weekends.



📖 NOTE

Check and follow the local regulations as to sound level and hours of operations for the product.

BEFORE STARTING THE ENGINE

1. Operate the chain saw only in well ventilated areas. Never start or run the engine inside a closed room or building. Exhaust fumes contain dangerous carbon monoxide.
2. The area within a perimeter of 15 m of the person using the product should be considered a hazardous area into which no one should enter. If necessary, yellow warning rope, warning signs should be placed around the perimeter of the area. When work is to be performed simultaneously by two or more persons, care should also be taken to constantly look around or otherwise check for the presence and locations of other people working so as to maintain a distance between each person sufficient to ensure safety.
3. Check the condition of working area to avoid any accident by hitting hidden obstacles such as stumps, stones, cans, or broken glass.



▲ 5. For safe operation

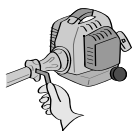

❗ IMPORTANT

Remove any obstacle before beginning work.

- Inspect the entire unit for loose fasteners and fuel leakage. Make sure that the cutting attachment is properly installed and securely fastened.
- Always use the harness. Adjust the harness for comfort before starting the engine. The harness should be adjusted so the left hand can comfortably hold the handlebar grip approximately waist high.

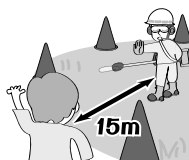

STARTING THE ENGINE

- Keep bystanders and animals at least 15 m away from the operating point. If you are approached, immediately stop the engine.
- The product is equipped with a centrifugal clutch mechanism, so the cutting attachment begins to rotate as soon as the engine is started by putting the throttle trigger into the start position. When starting the engine, place the product onto the ground in a flat clear area and hold it firmly in place so as to ensure that neither the cutting part nor the throttle come into contact with any obstacle when the engine starts.

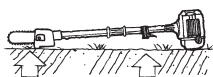

▲ WARNING

Never place the throttle trigger into the high-speed position when starting the engine.

- After starting the engine, check to make sure that the cutting attachment stops rotating when the throttle is moved fully back to its original position. If it continues to rotate even after the throttle trigger has been moved fully back, turn off the engine and take the unit to your authorized ZENOAH servicing dealer for repair.

USING THE PRODUCT

❗ IMPORTANT

Cut only materials recommended by the manufacturer. And use only for tasks explained in the manual.



- Grip the handles firmly with both hands using your whole hand. Place your feet slightly apart (slightly further apart than the width of your shoulders) so that your weight is distributed evenly across both legs, and always be sure to maintain a steady, even posture while working.
- Maintain the speed of the engine at the level required to perform cutting work, and never raise the speed of the engine above the level necessary.
- Never operate the pruner at an angle greater than 60° in order to reduce the risk of being struck by falling objects during operation.
- If the unit starts to shake or vibrate,

turn off the engine and check the whole unit. Do not use it until the trouble has been properly corrected.

- Keep all parts of your body away from rotating cutting attachment and hot surfaces.
- Never touch the muffler, spark plug, or other metallic parts of the engine while the engine is in operation or immediately after shutting down the engine. Doing so could result in serious burns or electrical shock.

▲ WARNING

Approaching or contacting electric power lines with the pruner may cause serious injury death from electrocution. Electricity can jump from one point to another by means arcing or may be conducted through damp branches. Maintain a clearance of at least 15m between the pruner and any electrical line carrying live current.



• IF SOMEONE COMES

- Guard against hazardous situations at all times. Warn adults to keep pets and children away from the area. Be careful if you are approached. Injury may result from flying debris.
- If someone calls out or otherwise interrupts you while working, always be sure to turn off the engine before turning around.

MAINTENANCE

- In order to maintain your product in proper working order, perform the maintenance and checking operations described in the manual at regular intervals.
- Always be sure to turn off the engine and disconnect the spark plug wire before performing any maintenance or checking procedures.

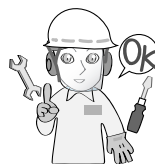

▲ WARNING

The metallic parts reach high temperatures immediately after stopping the engine.



- When replacing the cutting attachment or any other part, or when replacing the oil or any lubricant, always be sure to **use only ZENOAH products or products which have been certified by ZENOAH for use with the ZENOAH product.**
- In the event that any part must be replaced or any maintenance or repair work not described in this manual must be performed, please contact a representative from the store nearest ZENOAH authorized servicing dealer for assistance.
- Do not use any accessory or attachment other than those bearing the ZENOAH mark and recommended for the unit.
- Under no circumstances should you ever take apart the product or alter it in any way. Doing so might result in the product becoming damaged during operation or the product becoming unable to operate properly.

▲ 5. For safe operation



HANDLING FUEL

1. The engine of the ZENOAH product is designed to run on a mixed fuel, which contains highly flammable gasoline. Never store cans of fuel or refill the tank of the unit in any place where there is a boiler, stove, wood fire, electrical sparks, welding sparks, or any other source of heat or fire which might ignite the fuel.
2. Never smoke while operating the unit or refilling its fuel tank.
3. When refilling the tank, always turn off the engine and allow it to cool down. Take a careful look around to make sure that there are no sparks or open flames anywhere nearby before refueling.
4. Wipe spilled fuel completely using a dry rag if any fuel spillage occurs during refueling.
5. After refueling, screw the fuel cap back tightly onto the fuel tank and then carry the unit to a spot 3 m or more away from where it was refueled before turning on the engine.

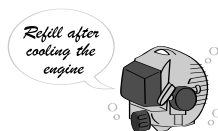

TRANSPORTATION

1. When you finish cutting in one location and wish to continue work in another spot, turn off the engine, lift up the unit and carry it paying attention to the blade.
2. Never forget to place the protective cover over the blades.
3. When hand-carrying the product, cover over the cutting attachment if necessary, lift up the product and carry it paying attention to the cutting attachment.
4. Never transport the product over rough roads over long distances by vehicle without removing all fuel from the fuel tank. If doing so, fuel might leak from the tank during transport.

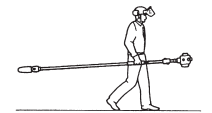

KICKBACK SAFETY PRECAUTIONS FOR CHAIN SAW USERS

▲ WARNING

- Kickback may occur when the nose or tip of the guide bar touches an object, or when the wood closes in and pinches the saw chain in the cut. Tip contact in some cases may cause a lightning fast reverse reaction, kicking the guide bar up and back towards the operator. Pinching the saw chain along the top of the guide bar may push the guide bar rapidly back towards the operator. Either of these reactions may cause you to lose control of the saw, which could result in serious personal injury.
- Do not rely exclusively on the safety devices built into your saw. As a chain saw user you should take sev-

eral steps to keep cutting jobs free from accident or injury.

- (1) With a basic understanding of kickback you can reduce or eliminate the element of surprise. Sudden surprise contributes to accidents.
- (2) Keep a good grip on the saw with both hands, the right hand on the rear handle, and the left hand on the front handle, when the engine is running. Use a firm grip with thumbs and fingers encircling the chain saw handles. A firm grip will help you reduce kickback and maintain control of the saw.
- (3) Make certain that the area in which you are cutting is free from obstructions. Do not let the nose of the guide bar contact a log, branch, or any other obstruction which could be hit while you are operating the saw.
- (4) Cut at high engine speeds.
- (5) Follow the manufacturer's sharpening and maintenance instructions for the saw chain.
- (6) Only use replacement bars and chains specified by the manufacturer or the equivalent.



▲ WARNING

- Make sure the chain and sprocket are correctly adjusted before operating the pruner (see page 7~8 for adjustment procedures). Never attempt chain adjustment with the engine running!
- Always make sure the cutting attachment is properly installed and firmly tightened before operation.
- Never use a cracked or warped guide bar: replace it with a serviceable one and make sure it fits properly.
- If saw chain should bind fast in a cut, shut off the engine immediately. Push the branch or tree to ease the bind and free saw chain.
- Do not operate the pruner with the muffler removed.
- When cutting a limb that is under tension, be alert for springback so that you will not be struck by the moving limb.
- Always stop the engine immediately and check for damage if you strike a foreign object or if the machine becomes tangled. Do not operate with broken or damaged equipment.

ⓘ IMPORTANT

- Do not make unauthorized modifications or substitutions to the guide bar or chain.
- Never allow the engine to run at high RPM without a load. Doing so could damage the engine.
- Keep the pruner as clean as possible. Keep it free of loose vegetation, mud, etc



6. Set up

MOUNTING ENGINE

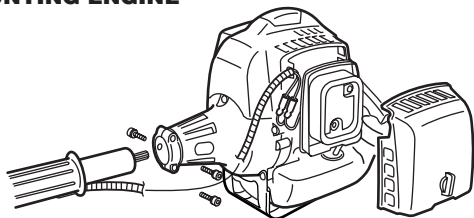

1. Push the shaft tube toward the clutch housing and rotate it by hand to check that the power transmission shaft is engaged with the gears.
2. Insert the power transmission shaft housing into the clutch housing until it bottoms, and align the positioning holes on the clutch housing and the shaft tube and install the screw. When difficult to engage, twist the engine slightly.
3. Fasten the clamp securely with two screws.

ⓘ IMPORTANT

Tighten the screws gradually by turns.

CONNECTING THROTTLE WIRE

1. Remove the air cleaner cover.
2. Connect the end of the throttle wire to the joint on the top of the carburetor.

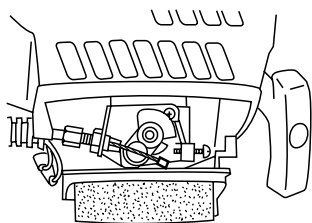

CONNECTING SWITCH WIRES

- Connect the switch wires between the engine and the main unit. Pair the wires of the same color.

ATTACHING THE PRUNING MECHANISM

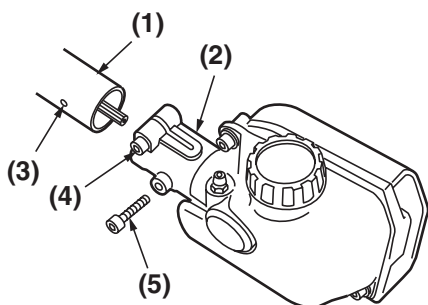

- (1) Tube (2) Transmission
(3) Screw hole (4) Fastening bolt
(5) Bolt

1. Remove the cap on the end of the tube.
2. Remove the bolt screwed into the end of the transmission.
3. Insert the end of the tube into transmission.
4. Line up the hole on the end of the transmission into which the bolt is to be inserted with the screw hole on the tube, and screw the bolt firmly in.
5. Using a wrench, screw the bolt provided to fix the mechanism into place.

A standard package contains the items as shown below.

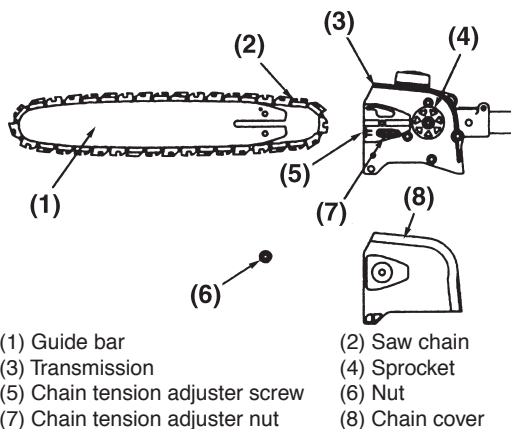

Install the guide bar and the saw chain on the transmission as follows.

⚠ WARNING

The saw chain has very sharp edges. Use protective gloves for safety.

1. Loosen a nut and remove the chain cover.
2. Mount the guide bar then fit the saw chain around the guide bar and sprocket.

⚠ WARNING

Pay attention to the correct direction of the saw chain.

3. Fit the chain tension adjuster nut into the lower hole of the guide bar, then install the chain cover, and fasten the mounting nut to finger tightness.

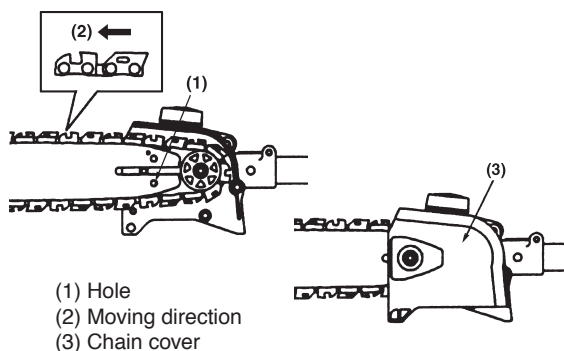

4. Adjust the chain tension by turning the chain tension adjuster screw until the tie straps just touch the bottom side of the bar rail.

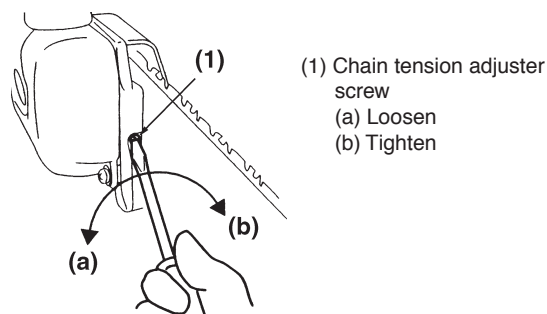

6. Set up

5. Tighten the mounting nut securely with the bar tip held up (TORQUE: 8.9 - 11.7 N.m./90 - 120 kg-cm). Then check the saw chain for smooth rotation and correct tension while moving it by hand. If necessary, readjust.

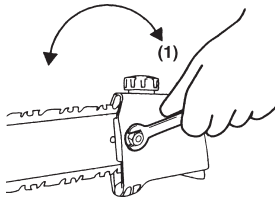

(1) Tighten

▲ WARNING

It is very important to maintain the proper chain tension. Rapid wear of the guide bar or the chain coming off easily can be caused by improper tension. Especially when using a new chain, take good care of it since it should expand when first used.

HARNESSES

▲ WARNING

ALWAYS WEAR THE PROVIDED HARNESSES WHEN USING THE MACHINE!

Always make sure the machine is hooked securely to the harness.

If you don't, you will be unable to control the machine safely. This can result in injury to yourself or others.

Never use a harness with a defective quick release or any other damage.

HOW TO WEAR

1. Wear the provided harness without twisted bands, with the hanger on your right side.

(1) Hanger

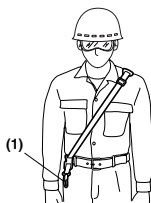

(Single harness)

BALANCE UNIT

1. Put on harness and attach unit to harness.
2. Depending on the working posture, slide clamp up or down until unit balances and the harness fits your body.

QUICK RELEASE

The harness is equipped with a "QUICK RELEASE" device. To release the machine from the harness in emergency situations, please follow the procedure as explained below.

▲ WARNING

Make sure to check proper working of the QUICK RELEASE device BEFORE operating the machine. Make sure to hold the unit securely when using the QUICK RELEASE.

While holding the unit by your left hand securely, press both sides of the buckle.

(1) Buckle

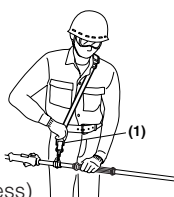

(Single harness)

7. Fuel and chain oil

■ FUEL

▲ WARNING

- Gasoline is very flammable. Avoid smoking or bringing any flame or sparks near fuel. Make sure to stop the engine and allow it cool before refueling the unit. Select outdoor bare ground for fueling and move at least 3 m (10 ft) away from the fueling point before starting the engine.



- The Zenoah engines are lubricated by oil specially formulated for air-cooled 2-cycle gasoline engine use. If Zenoah oil is not available, use an anti-oxidant added quality oil expressly labeled for air-cooled 2-cycle engine use (JASO FC GRADE OIL or ISO EGC GRADE).
- Do not use BIA or TCW (2-stroke water-cooling type) mixed oil.

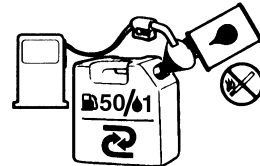

■ RECOMMENDED MIXING RATIO GASOLINE 50 : OIL 1

(when using ZENOAH genuine oil)

- Exhaust emission are controlled by the fundamental engine parameters and components (eq., carburation, ignition timing and port timing) without addition of any major hardware or the introduction of an inert material during combustion.
- These engines are certified to operate on unleaded gasoline.
- Make sure to use gasoline with a minimum octane number of 89RON (USA/Canada: 87AL).
- If you use a gasoline of a lower octane value than prescribed, there is a danger that the engine temperature may rise and an engine problem such as piston seizing may consequently occur.
- Unleaded gasoline is recommended to reduce the contamination of the air for the sake of your health and the environment.
- Poor quality gasolines or oils may damage sealing rings, fuel lines or fuel tank of the engine.

■ HOW TO MIX FUEL

▲ WARNING

- Pay attention to agitation.

1. Measure out the quantities of gasoline and oil to be mixed.
2. Put some of the gasoline into a clean, approved fuel container.
3. Pour in all of the oil and agitate well.
4. Pour in the rest of gasoline and agitate again for at least one minute. As some oils may be difficult to agitate depending on oil ingredients, sufficient agitation is necessary for the engine to last long. Be

7. Fuel and chain oil

careful that, if the agitation is insufficient, there is an increased danger of early piston seizing due to abnormally lean mixture.

- Put a clear indication on the outside of the container to avoid mixing up with gasoline or other containers.
- Indicate the contents on outside of container for easy identification.

■ FUELING THE UNIT

- Untwist and remove the fuel cap. Rest the cap on a dustless place.
- Put fuel into the fuel tank to 80% of the full capacity.
- Fasten the fuel cap securely and wipe up any fuel spillage around the unit.

▲ WARNING

- Select flat and bare ground for fueling.
- Move at least 10 feet (3 meters) away from the fueling point before starting the engine.
- Stop the engine before refueling the unit. At that time, be sure to sufficiently agitate the mixed gasoline in the container.

■ FOR YOUR ENGINE LIFE, AVOID:

- FUEL WITH NO OIL (RAW GASOLINE) – It will cause severe damage to the internal engine parts very quickly.
- GASOHOL – It can cause deterioration of rubber and/or plastic parts and disruption of engine lubrication.
- OIL FOR 4-CYCLE ENGINE USE – It can cause spark plug fouling, exhaust port blocking, or piston ring sticking.
- Mixed fuels which have been left unused for a period of one month or more may clog the carburetor and result in the engine failing to operate properly.
- In the case of storing the product for a long period of time, clean the fuel tank after rendering it empty. Next, activate the engine and empty the carburetor of the composite fuel.
- In the case of scrapping the used mixed oil container, scrap it only at an authorized repository site.

📖 NOTE

As for details of quality assurance, read the description in the section Limited Warranty carefully. Moreover, normal wear and change in product with no functional influence are not covered by the warranty. Also, be careful that, if the usage in the instruction manual is not observed as to the mixed gasoline, etc. described therein, it may not be covered by the warranty.

■ CHAIN OIL

Use motor oil SAE #10W-30 all year round or SAE #30 - #40 in summer and SAE #20 in winter.

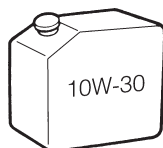

📖 NOTE

Do not use wasted or regenerated oil that can cause damage to the oil pump.

8. Operation

▲ WARNING

The cutting head will start rotating upon the engine starts.

- Feed fuel into the fuel tank and tighten the cap securely.

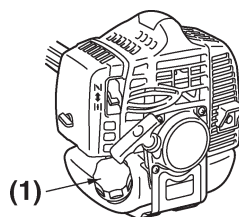

Feed the chain oil into the oil tank and tighten the cap securely, too.

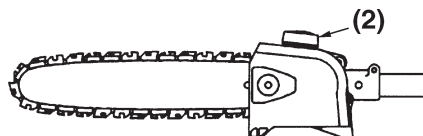

(1) Fuel

(2) Chain oil

- Rest the unit on a flat, firm place. Keep the cutting head off the ground and clear of surrounding objects, as it will start rotating upon starting of the engine.
- Push the primer pump several times until overflow fuel flows out in the clear tube.

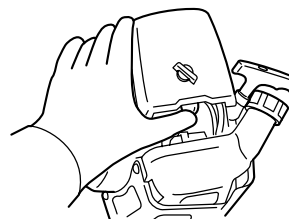

- Move the choke lever to the closed position.

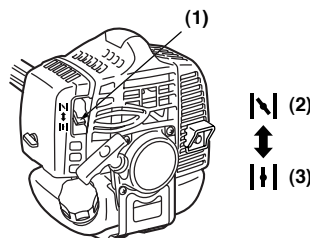

(1) Choke lever (2) Close (3) Open

- Set the stop switch to the “-” position. Set the throttle trigger to the start position (1 → 2 → 3). Place the unit on a flat, firm place. Keep the cutting head clear of everything around it.

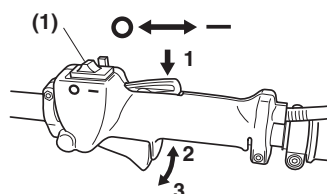

(1) Stop switch

8. Operation

6. While holding the unit firmly, pull out the starter rope quickly until engine fires.

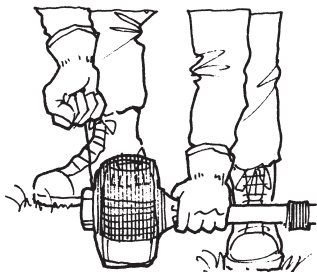

⚠ WARNING

The product is equipped with a centrifugal clutch mechanism, so the cutting attachment begins to rotate as soon as the engine is started by putting the throttle trigger into the start position. When starting the engine, place the product onto the ground in a flat clear area and hold it firmly in place so as to ensure that neither the cutting part nor the throttle trigger come into contact with any obstacle when the engine starts.

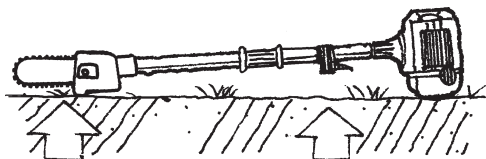

ⓘ IMPORTANT

- Avoid pulling the rope to its end or returning it by releasing the knob. Such actions can cause starter failures.
7. Move the choke lever downward to open the choke. And restart engine.

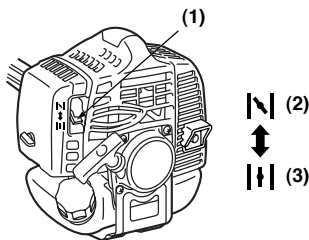

(1) Choke lever (2) Close (3) Open

8. Allow the engine to warm up for a several minutes before starting operation.

📖 NOTE

1. When restarting the engine immediately after stopping it, leave the choke open.
2. Overchoking can make the engine hard to start due to excess fuel. When the engine failed to start after several attempts, open the choke and repeat pulling the rope, or remove the spark plug and dry it.

STOPPING ENGINE

1. Release the throttle lever and run the engine for half a minute.
2. Shift the ignition switch to the STOP position.

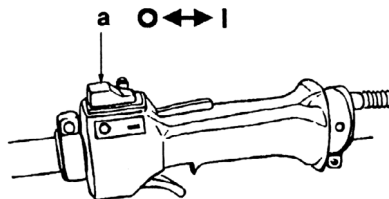

ⓘ IMPORTANT

- Except for an emergency, avoid stopping the engine while pulling the throttle lever.
- When it doesn't stop at the stop switch, move the choke lever to the closed position.



ADJUSTING THROTTLE CABLE

- The normal play is 1 or 2 mm when measured at the carburetor side end. Readjust with the cable adjuster as required and tighten the screw up.

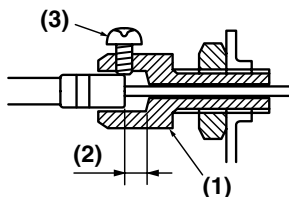

(1) Cable adjuster
(2) 0.04in (1~2mm)
(3) Screw

ADJUSTING IDLING SPEED

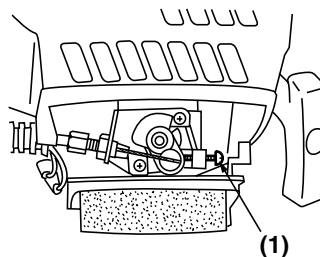

(1) Idle speed adjuster

1. When the engine tends to stop frequently at idling mode, turn the adjusting screw clockwise.
2. When the cutting head keeps rotating after releasing the throttle trigger, turn the adjusting screw counter-clockwise.

📖 NOTE

- Warm up the engine before adjusting the idling speed.

8. Operation

Checking oil supply

After starting the engine, run the chain at medium speed and see if chain oil has scattered off, as shown in the figure.

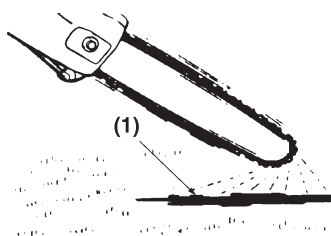

(1) Chain oil

NOTE

The oil reservoir has a capacity sufficient to provide about 40 minutes of cutting time (when set to deliver the minimum flow rate, or about as long as you'll get from a tank of fuel). Be sure to refill the oil tank every time when refuelling the saw.

Adjusting Oil Flow Rate

WARNING

Never fill the oil reservoir nor adjust the oiler with the engine running.

IMPORTANT

An increase in bar oil flow rate will speed oil consumption, requiring more frequent checks on the oil reservoir. To ensure sufficient lubrication, it may be necessary to check the oil level more frequently than at fuel tank refills.

The guide bar and chain are lubricated automatically by a pump that operates whenever the chain rotates. The pump is set at the factory to deliver a minimum flow rate, but it can be adjusted in the field. A temporary increase in oil flow is often desirable when cutting things like hardwood or wood with a lot of pitch.

Adjust the pump as follows:

1. Stop the engine and make sure the stop switch is in the OFF position.
2. Place the unit on its side with the oil reservoir up.

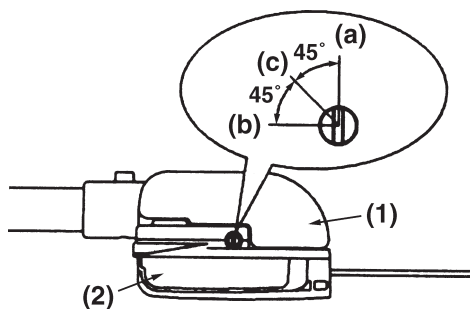

(1) Oil tank (2) Chain cover

IMPORTANT

The oil flow adjusting screw must be pressed in slightly in order to turn. Failure to do so could damage the pump and screw.

3. With a screwdriver, push in on the oil flow rate adjusting screw and turn in the desired direction (there are three incremental settings):
 - (a) Clockwise-decrease lubrication
 - (b) Counter clockwise-increase lubrication
 - (c) Middle

WARNING

- Always wear work gloves made of leather or some other sturdy material when using the pruner.
- Falling branches may fall onto the face or into the eyes, resulting in injuries, scratches, and cuts, and for this reason you should always be sure to wear a helmet and face protector when using your pruner.



9. Maintenance

	System/components	Procedure	Before use	Every 25 hours after	Every 50 hours after	Every 100 hours after	Note
ENGINE	fuel leaks, fuel spillage	wipe out	✓				
	fuel tank, air filter, fuel filter	inspect/clean	✓	✓			replace, if necessary
	idle speed adjuster	see adjusting idling speed (p. 10)	✓				replace carburetor if necessary
	spark plug	clean and readjust plug gap			✓		GAP: 0.65 mm replace, if necessary
	intake air cooling vent	clean		✓			
SHAFT	throttle trigger, stop switch	check operation	✓				
	transmission	grease		✓			
	screws/nuts/bolts	tighten/replace	✓			✓	not adjusting screws
CUTTING UNIT	oiling port	clean	✓			✓	
	guide bar	clean	✓				
	sprocket	inspect/replace			✓		
	saw chain	inspect/sharp	✓				

⚠ WARNING

- **Make sure that the engine has stopped and is cool before performing any service to the machine. Contact with moving cutting head or hot muffler may result in a personal injury.**

AIR FILTER

- The air filter, if clogged, will reduce the engine performance. Check and clean the filter element in warm, soapy water as required. Dry completely before installing. If the element is broken or shrunk, replace with a new one.

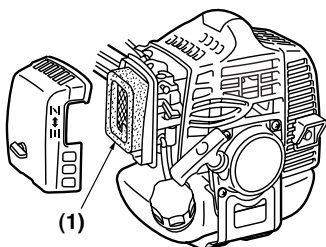

(1) Air filter

FUEL FILTER

- When the engine runs short of fuel supply, check the fuel cap and the fuel filter for blockage.

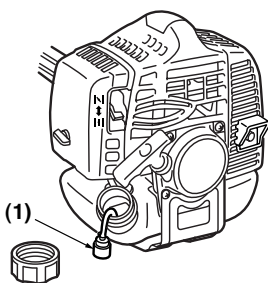

(1) Fuel filter

SPARK PLUG

- Starting failure and misfiring are often caused by a fouled spark plug. Clean the spark plug and check that the plug gap is in the correct range. For a replacement plug, use the correct type specified by ZENOAH.

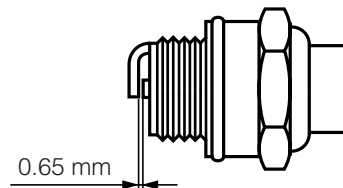

- **REPLACEMENT PLUG IS A NGK CMR7A.**

ⓘ IMPORTANT

- Note that using any spark plug other than those designated may result in the engine failing to operate properly or in the engine becoming overheated and damaged.
- To install the spark plug, first turn the plug until it is finger tight, then tighten it a quarter turn more with a socket wrench.

TIGHTENING TORQUE: 9.8 - 11.8 N.m.
(1 - 1.2 kg.m.)

MUFFLER

⚠ WARNING

- **Inspect periodically, the muffler for loose fasteners, any damage or corrosion. If any sign of exhaust leakage is found, stop using the machine and have it repaired immediately in the repair specialty store.**
- **Note that failing to do so may result in the engine catching on fire.**

9. Maintenance

SPARK ARRESTER

- The muffler is equipped with a spark arrester to prevent red hot carbon from flying out of the exhaust outlet. Periodically inspect and clean as necessary with a wire brush in the repair specialty store.

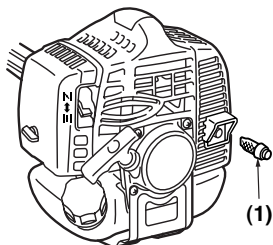

(1) Spark arrester

INTAKE AIR COOLING VENT

⚠ WARNING

- Check the intake air cooling vent after every 25 hours of use for blockage, and remove any waste which has attached itself to the machine.

❗ IMPORTANT

- If waste gets stuck and causes blockage around the intake air cooling vent, it may cause the engine to overheat, and that in turn may cause mechanical failure on the part of the machine.

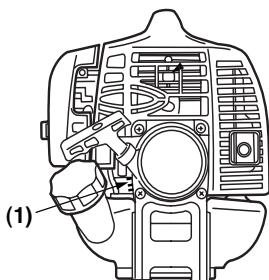

(1) Intake air cooling vent (back)

OILING PORT

Dismount the guide bar and check the oiling port for clogging. (MA1)

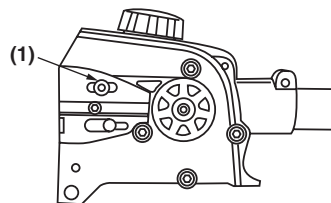

(1) Oiling port

GUIDE BAR

Remove sawdust in the guide bar groove and the oiling port.

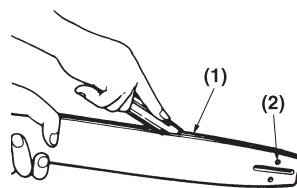

(1) Groove (2) Oiling port

(Type: Sprocket nose)

Grease the nose sprocket from the feeding port on the tip of the bar.

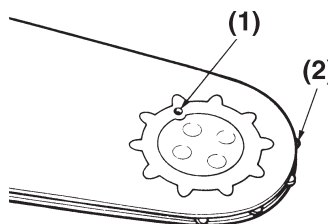

(1) Grease port (2) Sprocket

The guide bar rail should always be a square. Check for wear of the guide bar rail. Apply a ruler to the bar and the outside of a cutter. If a gap is observed between them, the guide bar rail is normal. Otherwise, the guide bar rail is worn. Such a bar needs to be corrected or replaced.

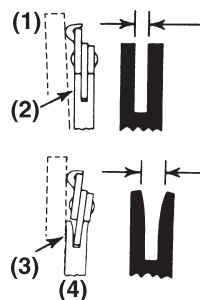

(1) Ruler (2) Gap
(3) No gap (4) Chain tilts

9. Maintenance

SPROCKET

Check for extensive wear, and replace it when the teeth are worn over 0.3 mm.

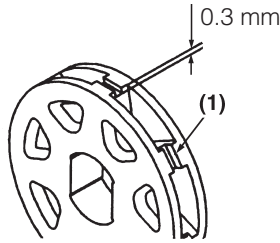

(1) Sprocket

SAW CHAIN

▲ WARNING

It is very important for smooth and safe operation to keep the cutters always sharp.

Your cutters need to be sharpened when:

- Sawdust becomes powder-like.
- You need extra force to saw in.
- The cut way does not go straight.
- Vibration increases.
- Fuel consumption increases.

Cutter setting standards:

▲ WARNING

Be sure to wear safety gloves.

Before filing:

- Make sure the saw chain is held securely.
- Make sure the engine is stopped.
- Use a round file of proper size for your chain.

Chain type : 90SG
File size : 5/32 in (4.0 mm)

Place your file on the cutter and push straightforward. Keep the file position as illustrated.

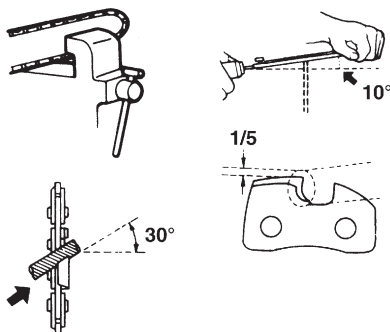

After every cutter has been set, check the depth gauge and file it to the proper level as illustrated. (MA7)

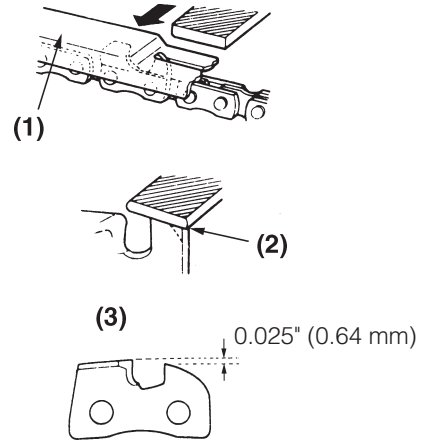

- (1) Appropriate gauge checker
(2) Make the shoulder round
(3) Depth gauge standard

▲ WARNING

Be sure to round off the front edge to reduce the chance of kickback or tie-strap breakage.

Make sure every cutter has the same length and edge angles as illustrated.

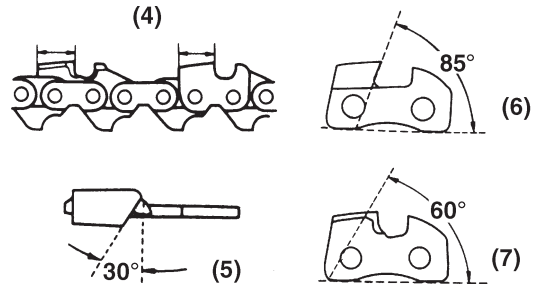

- (4) Cutter length
(5) Filing angle
(6) Side plate angle
(7) Top plate cutting angle

TRANSMISSION

The reduction gears are lubricated by multipurpose, lithium-based grease in the transmission.

Supply new grease every 25 hours of use or more often depending on the job condition.

When adding lubricant, use a grease gun to insert lubricant into the three grease nipples located on the transmission.

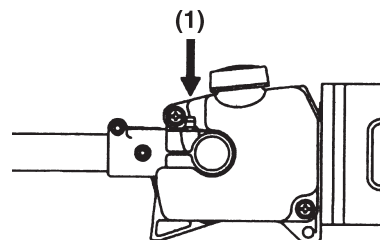

(1) Grease fitting

10. Storage

Aged fuel is one of major causes of engine starting failure. Before storing the unit, empty the fuel tank and run the engine until it uses all the fuel left in the fuel line and the carburetor. Store the unit indoor taking necessary measures for rust prevention.

11. Disposal

- When you dispose of the machine, do not disassemble the machine.
- When you dispose of the machine, fuel, oil, be sure to follow your local regulations.

12. Troubleshooting guide

Case 1. Starting failure

CHECK	PROBABLE CAUSES	ACTION
fuel tank	→ incorrect fuel	→ drain it and use correct fuel
fuel filter	→ fuel filter is clogged	→ clean
carburetor adjustment screw	→ out of normal range	→ adjust to normal range
sparkling (no spark)	→ spark plug is fouled/wet	→ clean/dry
	→ plug gap is incorrect	→ correct (GAP: 0.65 mm)
spark plug	→ disconnected	→ retighten

Case 2. Engine starts but does not keep running/hard re-starting

CHECK	PROBABLE CAUSES	ACTION
fuel tank	→ incorrect fuel or staled fuel	→ drain it and use correct fuel
carburetor adjustment screw	→ out of normal range	→ adjust to normal range
muffler, cylinder (exhaust port)	→ carbon is built-up	→ consult with the repair specialty store
air cleaner	→ clogged with dust	→ air blow or wash
cylinder fin, fan cover	→ clogged with dust	→ consult with the repair specialty store

When your unit seems to need further service, please consult with our ZENOAH service shop in your area.

Limited warranty

Should any failure occur on the product under normal operating conditions within the applicable warranty period, the failed part will be replaced or repaired free of charge by a ZENOAH authorized dealer.

WARRANTY PERIOD: 1 year (6 months if used professionally, and 30 days if used for rental purpose) from the date of initial purchase.

THE PURCHASER SHALL BEAR COSTS OF TRANSPORTING THE UNIT TO AND FROM THE ZENOAH DEALER.

THE PURCHASER SHALL NOT BE CHARGED FOR DIAGNOSTIC LABOR WHICH LEADS TO THE DETERMINATION THAT A WARRANTED PART IS DEFECTIVE, IF THE DIAGNOSTIC WORK IS PERFORMED AT THE ZENOAH DEALER.

THE PURCHASER OR OWNER IS RESPONSIBLE FOR THE PERFORMANCE OF THE REQUIRED MAINTENANCE AS DEFINED BY THE MANUFACTURER IN THE OWNER/OPERATOR MANUAL.

ANY WARRANTED PART WHICH IS NOT SCHEDULED FOR REPLACEMENT AS REQUIRED MAINTENANCE, OR WHICH IS SCHEDULED ONLY FOR REGULAR INSPECTION TO THE EFFECT OF REPAIR OR "REPLACE AS NECESSARY" SHALL BE WARRANTED FOR THE WARRANTY PERIOD. ANY WARRANTED PART WHICH IS SCHEDULED FOR REPLACEMENT AS REQUIRED MAINTENANCE SHALL BE WARRANTED FOR THE PERIOD OF TIME UP TO THE FIRST SCHEDULED REPLACEMENT POINT FOR THE PART.

ANY REPLACEMENT PART THAT IS EQUIVALENT IN PERFORMANCE AND DURABILITY MAY BE USED IN NON-WARRANTY

MAINTENANCE OR REPAIRS, AND SHALL NOT REDUCE THE WARRANTY OBLIGATION OF THE COMPANY.

THE COMPANY IS LIABLE FOR DAMAGES TO OTHER ENGINE COMPONENTS CAUSED BY THE FAILURE OF A WARRANTED PART STILL UNDER WARRANTY.

THE WARRANTY DOES NOT APPLY TO THOSE UNITS WHICH HAVE BEEN DAMAGED BY NEGLIGENCE OF INSTRUCTION LISTED IN THE OWNER/OPERATOR MANUAL FOR PROPER USE AND MAINTENANCE OF THE UNITS ACCIDENT MISHANDLING, ALTERATION, ABUSE, IMPROPER LUBRICATION, USE OF ANY PARTS OR ACCESSORIES OTHER THAN THOSE SPECIFIED BY THE COMPANY, OR OTHER CAUSES BEYOND THE COMPANY'S CONTROL.

THIS WARRANTY DOES NOT COVER THOSE PARTS REPLACED BY NORMAL WEAR OR HARMLESS CHANGES IN THEIR APPEARANCE.

THERE ARE NO OTHER EXPRESS WARRANTIES.

IMPLIED WARRANTIES INCLUDING THOSE OF MERCHANTABILITY AND FITNESS FOR A PARTICULAR PURPOSE **ARE LIMITED** TO TWO (2) YEARS OF HOME USE [ONE (1) YEAR FOR ANY OTHER USE] FROM THE ORIGINAL DELIVERY DATE.

LIABILITIES FOR INCIDENTAL OR CONSEQUENTIAL DAMAGE UNDER ANY AND ALL WARRANTIES ARE EXCLUDED.

IF YOU NEED TO OBTAIN MORE INFORMATION, PLEASE CALL YOUR NEAREST SERVICE CENTER, OR CHECK PLEASE ZENOAH WEB SITE <http://www.zenoah.net>

To Dealer: Please complete the following form at time of sale.

Product Model: ZENOAH	Equipment No.:
<input type="checkbox"/> PSZ2600	Engine No.:
Date of Purchase: D / M / Y	Use: <input type="checkbox"/> Private
	<input type="checkbox"/> Professional
	<input type="checkbox"/> Rental
Purchaser: Name: _____	Dealer: Name: _____
Address/Phone: _____	Address/Phone: _____

To Purchaser: When your unit requires any repair, please bring or send it to the dealer with this sheet attached.



Husqvarna Zenoah Co., Ltd.

1-9 Minamidai, Kawagoe-city, Saitama, 350-1165 Japan

PRINTED IN JAPAN